

THE GAS-PHASE PHOTOCHEMICAL DECOMPOSITION OF THE SIMPLE ALIPHATIC KETONES^{1,2}

WALLACE DAVIS, JR.

Department of Chemistry, University of Rochester, Rochester, New York

Received January 14, 1947

CONTENTS

I. Introduction.....	201
II. Acetone.....	202
Summary of reactions.....	202
III. Ethyl methyl ketone.....	240
IV. Diethyl ketone.....	244
V. <i>n</i> -Butyl methyl ketone.....	245
VI. References.....	249

I. INTRODUCTION

The studies of the products of the photochemical decomposition of the simple aliphatic ketones such as acetone, ethyl methyl ketone, diethyl ketone, *n*-butyl methyl ketone, and the *n*- and isopropyl ketones have shed much light upon the stabilities and reactions of a number of organic free radicals as well as upon the type of bond that is broken during the photolysis. Acetone, ethyl methyl ketone, and diethyl ketone have been found to dissociate into CH₃, CH₃CO, C₂H₅, and C₂H₅CO radicals. Of these, only C₂H₅CO appears to be very unstable at room temperature. On the basis of the mechanisms proposed to explain the products produced from the photolysis of these three ketones, *a priori* one might have expected *n*-butyl methyl ketone to dissociate into acetyl and butyl radicals to yield final products such as ethane, pentane, octane, etc. However, the data now available indicate that the most important products, acetone and propylene, are formed in a one-step rearrangement reaction. Thus, in the notation of Norrish (41, 52), there are at least two types of primary process in the photolysis of the aliphatic ketones, the size of the groups R and R' determining the nature of the decomposition:

Type I:



Type II:



In this article only acetone, ethyl methyl ketone, diethyl ketone, and *n*-butyl methyl ketone are discussed. The first three, decomposing to radicals to a

¹ The author wishes to thank Professor G. K. Rollefson of the University of California, Professor P. A. Leighton of Stanford University, and Dr. R. Spence of the National Research Council of Canada for reading the manuscript and for making numerous suggestions and corrections. This reading does not constitute agreement with all statements made in this review.

² This article was completed while the author was employed on Navy Contract N6onr-241, Task I.

large extent, are typical of the Type I reaction, while *n*-butyl methyl ketone is the simplest aliphatic ketone that undergoes the Type II decomposition to a large extent.

II. ACETONE

The photodecomposition of acetone has been the subject, in part or in entirety, of more than fifty original publications (see bibliography), exclusive of many more on the absorption spectrum and fluorescence of acetone. The green fluorescence attributed to acetone prior to 1938 has since been rather conclusively shown to be due to biacetyl (4, 34, 45, 56). The weak blue fluorescence observed when acetone is irradiated with ultraviolet light in the presence of oxygen may be due to acetone, but this has not yet been proved conclusively.

Acetone, as well as other carbonyl compounds, such as other ketones and aldehydes, absorbs light in the ultraviolet, the upper wave-length limit being about 3200–3300 Å., or possibly a little higher (62). This upper limit has been shown to consist of a region of discrete absorption (15, 55), probably overlapping a continuum which extends to about 2100 Å. (62). A second absorption region beginning at about 1960 Å. and extending toward shorter wave lengths has been found (55) to consist of several groups of bands. This region extends to below 1800 Å. Acetone has also been shown (20) to exhibit discrete absorption down to about 1300 Å. and continuous absorption from 1300 Å. at least to 850 Å.

Whether there is a real difference between the region of continuous absorption between 2200 and 3050 Å. and the so-called region of discrete absorption extending from 3050 Å. to about 3300 Å. is questionable. Acetone, with twenty-four possible modes of vibration, would be expected to show a complex structure, the extreme types of structure being well-defined vibrational bands and vibrational bands overlapping in such a way as to have the appearance of a continuum. From 2200 to 3050 Å. acetone may really have a highly overlapping band structure rather than a truly continuous absorption; from 3050 to 3300 Å. the bands that are observed may be the only ones separated enough to permit their being called "bands" rather than part of a "continuous" absorption region.

Studies on the photochemical decomposition of acetone have been made in several of the above-mentioned absorption regions, specifically in the banded region at about 3100 Å., in the region of continuous absorption between about 2900 Å. and 2200 Å., or using approximately monochromatic 2537 Å. radiation from mercury arcs. Some work has also been performed using light of about 1900 Å. in the photolysis of acetone (37).

The products of the photolysis of acetone have been quite well established. At room temperatures (about 20–30°C.), carbon monoxide, ethane, and biacetyl have been identified by many authors, while methane is also formed to a small extent (71). As the temperature increases the amount of biacetyl formed decreases, until at 60–75°C. it becomes rather unimportant. Further, as the temperature increases above 80–100°C., methane and presumably ethyl methyl ketone are formed in appreciable quantities.

The reaction that takes place when acetone absorbs light, the primary process, probably follows one or more of the courses indicated by equations 1 to 4.

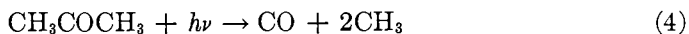
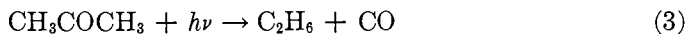
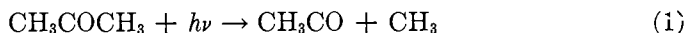

Kirkbride and Norrish (41) first suggested reactions 1, 3, and 4. Spence and Wild (71) considered reaction 2 necessary to explain their data from experiments in the "banded" absorption region around 3130 Å. Barak and Style (8) found biacetyl after the photolysis of acetone, proving the necessity of reaction 1. Spence and Wild (70) indicated the importance of reaction 1 with respect to reaction 4 under certain experimental conditions.

Pearson *et al.* (60, 61), using the Paneth mirror technique (57, 58, 59), found that when acetone is photolyzed in a flow system, usually with a mercury arc as a light source, there are formed radicals or atoms which will remove lead, tellurium, and antimony mirrors. These authors analyzed the products, found that metal methyls had been formed, and concluded that methyl radicals were produced in the primary process. Prileshajeva and Terinin (63) found that acetone, when irradiated with magnesium or iron sparks, gave products which removed metal mirrors.

Other evidence that radicals are produced by the photolysis of acetone has been provided by Taylor and Jungers (73) and by Danby and Hinshelwood (17), who found the polymerization of ethylene and acetylene to be induced by acetone when illuminated by ultraviolet light; by Taylor and Rosenblum (74), who found the products of the photolysis of acetone to react with hydrogen; by Gorin (28, 29, 30), who found methyl iodide and acetyl iodide to be formed when acetone is photolyzed in the presence of iodine; by Benson and Forbes (10), who found organic iodides, presumably methyl iodide and acetyl iodide, to be formed when acetone is photolyzed in the presence of iodine; by Feldman, Ricci, and Burton (25), who found lead mirrors to be removed by the photolysis products; and by Feldman, Burton, Ricci, and Davis (24), who determined the rate at which lead mirrors are removed by the products of the photolysis of acetone. Further, experiments on the effect of intensity of absorbed light and the pressures of foreign gases carried out by Leermakers (42), Howe and Noyes (37), Spence and Wild (71, 72), Herr and Noyes (36), Howland and Noyes (38, 39), Saunders and Taylor (69), and Iredale and Lyons (40) all indicate that the production of free radicals during the photolysis of acetone must be quite important.

Of course, one of the stronger pieces of evidence for the free-radical mechanism is derived from the analogy between acetone and ethyl methyl ketone. Norrish (51) first showed that from the latter, nearly equal amounts of the three hydrocarbons ethane, propane, and butane were formed. On the basis of a mechanism such as is suggested in equation 3, only propane would be expected from ethyl methyl ketone. Thus, the data rule out reaction 3 for this ketone and, by analogy, for acetone.

There are only a few ways in which the methyl radical could be formed. Only

reaction 1 or 4 would explain the appearance of CH_3 in the primary process. Reaction 2, if this were the primary process, would have to be followed by

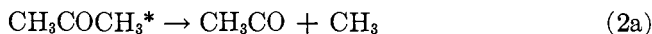

to explain the appearance of the radicals. Of course, it might be possible to write other, non-radical-producing reactions between 2 and 2a, but this would be rather superfluous. Certainly a reaction like 2a following reaction 2 would also be necessary to explain the presence of biacetyl (8, 70, 71), found to be formed at wave lengths from 2500–3100 Å. This product could hardly be expected to be formed by a reaction such as

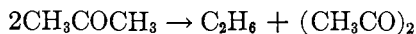

instead of a combination of acetyl radicals

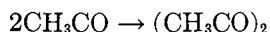

either homogeneously or heterogeneously.

The presence of free radicals in the photolysis of acetone and other information to be presented later makes reaction 3 appear to be a very unlikely reaction, and, of course, it could not explain the presence of biacetyl. However, reactions 1 and 4 can be used to explain the presence of CH_3 and CH_3CO , and the final products ethane, carbon monoxide, and biacetyl.

The reactions of the acetyl radicals are quite numerous. Glazebrook and Pearson (27) and Feldman, Ricci, and Burton (25) have found that after removal of methyl radicals by metal mirrors, if a second mirror farther from the reaction cell is heated, say to 45°C., more metal methyl is formed, presumably by the thermal reactions

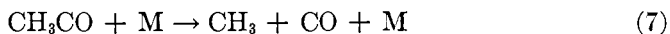

The over-all energy of activation for the thermal dissociation of the acetyl radical has been calculated by various authors (9, 30, 33, 36, 50, 65) to be between 10 and 18 kg.-cal. The energy per einstein of 3130 Å. light is about 91 kg.-cal., of 2537 Å. light about 113 kg.-cal. If we use the estimate of Rice and Herzfeld (65) of 70 kg.-cal. as the energy necessary to break one C—C bond in acetone, the excess energy retained by the radicals after dissociation is 21 and 43 kg.-cal., respectively, for 3130 and 2537 Å. light.

The distribution of this excess energy probably determines, in part, the fate of the acetyl radicals. If no C—H stretching or bending vibrations are excited, the only energy retained by the methyl radical occurs as translational energy, of which there are three degrees. In the acetyl radical, again omitting C—H vibrations, there will be three modes of vibration of the C—C=O skeleton and three degrees of translation. The vibrations of the acetyl radical contain between 7.5 and 15 kg.-cal. (C=O 1700 cm^{-1} , 4.9 kg.-cal.; C—C 900 cm^{-1} , 2.6 kg.-cal.) The remaining energy, appearing as energy of translation, will,

from considerations of momentum conservation, be divided roughly inversely as the radical weights. Then the ratio

$$\frac{E_{\text{trans}}(\text{CH}_3)}{E_{\text{trans}}(\text{CH}_3\text{CO})} \simeq \frac{2}{3} \text{ to } \frac{3}{4}$$

To a rough degree of approximation, then, after the dissociation of acetone into acetyl and methyl radicals, the acetyl radical will possess about 10 kg.-cal. as vibrational energy and 3-4 kg.-cal. as translational energy after irradiation with 3130 Å. light, a total of 13-14 kg.-cal. As mentioned above, the over-all energy of activation for the thermal decomposition of the acetyl radical has been calculated as 10-18 kg.-cal. The excess energy retained by the acetyl radical, even from acetone photolysis by 3130 Å. light, is very close to the energy of activation of the thermal decomposition reaction. We would therefore expect the occurrence, to a small degree after 3130 Å. irradiation, and to greater extents after 2537 Å. or 1900 Å. irradiation, of the spontaneous reaction



where ϕ_1 is the quantum yield of reaction 1, and α is a proportionality factor which is a function of wave length and temperature. CH_3CO^* is used to designate an activated acetyl radical.

Benson and Forbes (10) have calculated the values of α from their work using 2537 Å. light, from the work of Herr and Noyes at 2537 and 3130 Å. (36), and from the work of Howe and Noyes at 1900 Å. (37).

λ	α
3130	0.07
2537	0.22
1900	0.50

If reaction 5 occurs in such a short time that the time lag has no effect upon the extent to which the reaction takes place, then the sequence of reactions 1 and 5 is equivalent to the reaction

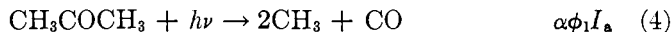

Since there appears to be no evidence to indicate anything but a very short life for CH_3CO^* , there is no difference between the use of a single primary process (reaction 1), followed to some extent by reaction 5, and the use of two primary processes, reactions 1 and 4.

The low value of α (0.07) at 3130 Å. probably explains why Gorin (30) found no carbon monoxide when he irradiated acetone with this wave length in the presence of iodine.

Acetyl radicals that have been deactivated by collision, or that are initially formed with insufficient energy to decompose spontaneously, can decompose thermally, since this reaction probably has an upper limit of activation energy of 18 kg.-cal. (see above).

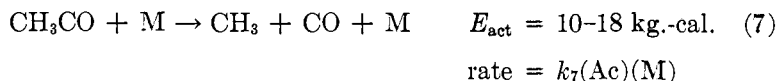

Equations 6 and 7 are simplifications of the over-all reactions:



Assuming steady-state conditions for the radicals of these reactions, we arrive at

$$k_{7a}(\text{Ac})(\text{M}) = k_{7b}(\text{Ac}^*) + k_{7c}(\text{Ac}^*)(\text{M})$$

whence

$$(\text{Ac}^*) = \frac{k_{7a}(\text{Ac})(\text{M})}{k_{7b} + k_{7c}(\text{M})}$$

Then the rate of formation of methyl radicals and carbon monoxide by the thermal decomposition of the acetyl radical appears as

$$\frac{d(\text{CO})_7}{dt} = \frac{k_{7b}k_{7a}(\text{Ac})(\text{M})}{k_{7b} + k_{7c}(\text{M})} = \frac{k_{7a}(\text{Ac})(\text{M})}{1 + \frac{k_{7c}}{k_{7b}}(\text{M})}$$

$$k_6 = \frac{k_{7a}(\text{M})}{1 + \frac{k_{7c}}{k_{7b}}(\text{M})}; \quad k_7 = \frac{k_{7a}}{1 + \frac{k_{7c}}{k_{7b}}(\text{M})}$$

At 25°C. Herr and Noyes (36) found the quantum yield of carbon monoxide formation to increase to a small extent with pressure at 3130 Å. ($I_a = 0.5 \times 10^{12}$ quanta/sec./cc.; $P_{\text{acetone}} = 10\text{-}160$ mm.) and at 2537 Å. ($I_a = 0.5 \times 10^{12}$ quanta/sec./cc.; $P_{\text{acetone}} = 5\text{-}195$ mm.). At 27°C. Howland and Noyes (39) found a slight increase of Φ_{CO} with pressure at 3130 Å. ($I_a = 3 \times 10^{12}$ quanta/sec./cc.; $P_{\text{acetone}} = 54\text{-}203$ mm.) and a slight decrease with pressure at 25-2700 Å. ($I_a = 1.2 \times 10^{12}$ quanta/sec./cc., or 12×10^{12} quanta/sec./cc.; $P_{\text{acetone}} = 50\text{-}160$ mm.). At 75°C. Herr and Noyes (36) again found the quantum yield of carbon monoxide formation to increase only slightly with acetone pressures up to 200 mm. at 3130 Å. or at 2537 Å. At these intensities the constants k_{7a} , k_{7b} , k_{7c} must predict approximate independence of Φ_{CO} with acetone pressure for acetone pressures above 50-100 mm. If (M) in equations 7a and 7c is expressed in millimeters of pressure, $\frac{k_{7c}}{k_{7b}}(\text{M})$ must be considerably greater than unity.

In this case

$$\frac{d(\text{CO})_7}{dt} = \frac{k_{7a}k_{7b}}{k_{7c}}(\text{Ac})$$

For this equation to fit the data of Herr and Noyes (36) or of Howland and Noyes (39)

$$\frac{k_{7c}}{k_{7b}} (M) \geq 10$$

(that is, "very much larger than unity"). At an acetone pressure of 100 mm., $\frac{k_{7c}}{k_{7b}} \geq 0.1$. Assuming the steady-state concentration of acetyl radicals to be nearly independent of pressure from 100–200 mm. acetone, the data of Herr and Noyes indicate $\frac{k_{7c}}{k_{7b}} \simeq 0.3$.

In agreement with experiment we may use equation 6 at moderate and high pressures. At low pressures equation 7 must be used.



At high pressures of foreign gases, Iredale and Lyons (40) found a considerable increase in the rate of formation of carbon monoxide.

TABLE 1
Effect of carbon dioxide on formation of carbon monoxide
2400–3100 Å.; 16 mm. exposures; I_a constant
(Iredale and Lyons (40))

PRESSURE OF ACETONE	PRESSURE OF CO ₂	CO FORMED AT N.T.P.
<i>mm.</i>	<i>mm.</i>	<i>cc.</i>
150	0	0.020
150	0	0.019
150	0	0.020
150	600	0.034
150	620	0.036
150	610	0.034
	Unilluminated	
150	630	0.0005

This increase in the rate of carbon monoxide formation might be attributed either to a decreased quantum yield for acetone decomposed or to the increased decomposition of the acetyl radical by the reaction:

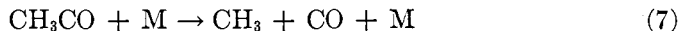

The latter possibility suggests that at high foreign gas pressures, biacetyl should cease to be formed, or $\text{C}_2\text{H}_6/\text{CO} \rightarrow 1$. This has been confirmed by Iredale and Lyons, as will be mentioned later.

The data of Iredale and Lyons (40) and those of Howland and Noyes (39) agree quite well with respect to the increased yield of carbon monoxide with the addition of carbon dioxide. The large increase observed is to be attributed to the inefficiency of carbon dioxide as the second body in the deactivating step (equation 7c) as compared to acetone.

The efficiency of the primary process (reaction 1), or processes 1 plus 2, has usually been assumed to be unity. This is not in disagreement with the work of Herr and Noyes (36) on the photolysis of acetone at 3130 Å. and at 2537 Å.

Unfortunately, experimental difficulties in working at very low pressures are so great that for the photolysis at 25°C. we can say no more than that Φ_{acetone} approaches a value not much less than unity, if less than unity at all (figures 1 and 2).

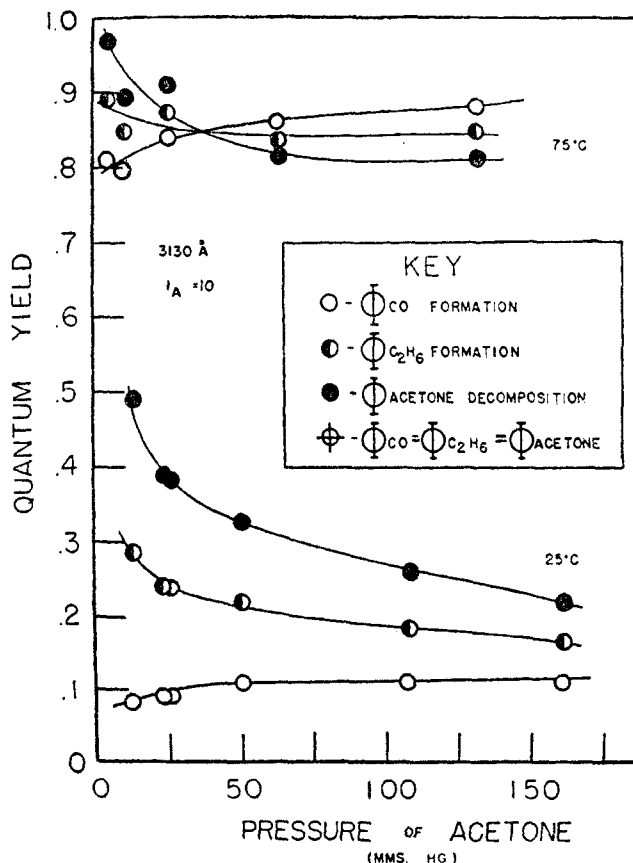
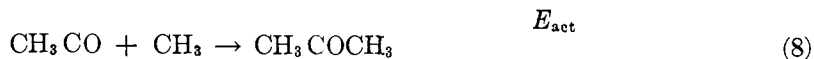

FIG. 1. Effect of pressure and temperature on quantum yields at 3130 Å. (Herr and Noyes (36).)

The explanation of the low over-all quantum yield of acetone decomposed is generally given by the recombination reaction (equation 8).



To compete, at moderate pressures and at room temperature, with reactions 9', 10, and 11', reaction 8 has been assigned an activation energy as low as zero. If reactions 8, 9', 10, and 11' were all gas-phase reactions at moderate pressures

(10–200 mm.) and moderate absorbed intensities (10^{11} – 10^{13} quanta/cc./sec.) at room temperatures, we might expect them to have about equal probabilities except for steric factors, since all activation energies are quite small. However, at very low pressures reaction 8 appears unimportant, the quantum yield of acetone decomposition approaching a value certainly not much less than unity. At higher pressures, Φ_{acetone} decreases, reaction 8 becoming quite important. We can reword these statements and say that at low pressures reactions 6, 7, 8, and 10 must be relatively unimportant, because of the low values of Φ_{CO} , while

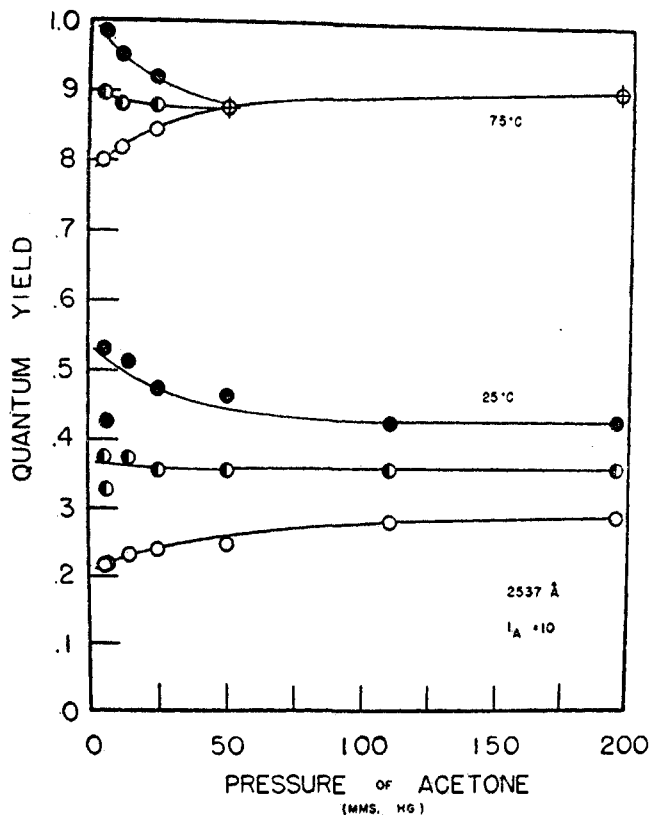
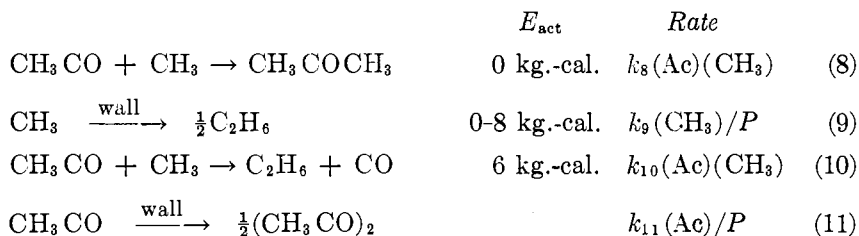

Fig. 2. Effect of pressure and temperature on quantum yields at 2537 Å. (Herr and Noyes (36).)

reactions 9' and 11', neither being considered to imply the kinetics of the radical combinations, remain important. Reaction 9' must remain important because of the increase of ethane formation as the pressure decreases. Reaction 11' must remain important to explain the absence of acetyl radicals for the formation of carbon monoxide.

The obvious conclusion to consider concerning reactions 9' and 11' is that these are both wall reactions. This would explain high values of ethane and biacetyl (calculated by a material balance), low values of carbon monoxide, and high values for the ratio $\text{C}_2\text{H}_6/\text{CO}$ at low pressures.

Also, with diffusion becoming unimportant at higher pressures, reactions 8 and 10 become more important, requiring these reactions to be homogeneous. Since the over-all quantum yield of acetone decomposition does not continue to decrease with increasing pressure, but, rather, attains a nearly constant value (figures 1 and 2), reaction 8 cannot be pressure dependent. The same reasoning holds for reaction 10; that is, Φ_{CO} and $\Phi_{\text{C}_2\text{H}_6}$ both attain approximately steady values as the pressure increases. These considerations assure us of the importance of the following reactions:



There are arguments both for and against reaction 10. In favor of this reaction or of a reaction unlike 6 or 7 is the low energy of activation, 8 kg.-cal., found by Gorin (30) for carbon monoxide formation when the photolysis is performed in the presence of iodine, as contrasted to most estimates of 14-18 kg.-cal. for reactions 6 or 7 (see above). Further, a reaction of this type might explain the low quantum yield of biacetyl formation above 60-75°C., assuming the acetyl radical to be stable enough at this temperature to exist in appreciable concentration. One other argument in favor of reaction 10 is the low yield of carbon monoxide (only about 8 per cent of methyl iodide) and the high yield of acetyl iodide found in the photolysis of acetone in the presence of iodine even at 100°C., at which temperature an activation energy of 14-18 kg.-cal. for reactions 6 and 7 would lead one to expect 60-90 per cent thermal decomposition of the acetyl radical. In contradiction of the necessity of reaction 10 is the geometry, which would require a possibly unexpected arrangement of hydrogen atoms in the acetyl radical to allow for the formation of ethane upon collision with a methyl radical. A high efficiency and/or a low activation energy for the reaction

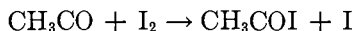

would explain the low quantum yield of carbon monoxide formation in the presence of iodine. Spence and Wild (71) reported $\text{C}_2\text{H}_6/\text{CO}$ of about 1.08 at 51°C. and 80 mm. pressure. This indicates that biacetyl is formed in small quantities at 50°C. Fluorescence data also indicate biacetyl formation at 85°C. (46). Experiments by Anderson and Rollefson (6) on the photolysis of acetone at about 50 mm. pressure indicate that traces of biacetyl are formed even at 110°C. At this pressure, as can be seen in table 8, biacetyl is quite important at 65°C.

In summary of the value of reaction 10 it can probably be said that this reaction is useful, but there is no irrefutable proof of its necessity. The presence or absence of biacetyl above 60-75°C. can be explained if reaction 10 is omitted, since reaction 6 or 7 predicts 60-90 per cent decomposition of the acetyl radical

at about 100°C., thus allowing for the presence of a small concentration of this radical at this temperature. At low pressures biacetyl might be expected at 60–75°C., or at high pressures and very high absorbed intensities. However, at moderate intensities, reactions 6 and 7 will be favored over reactions 11' or 12, each of which is a function of the square of the acetyl radical concentration.

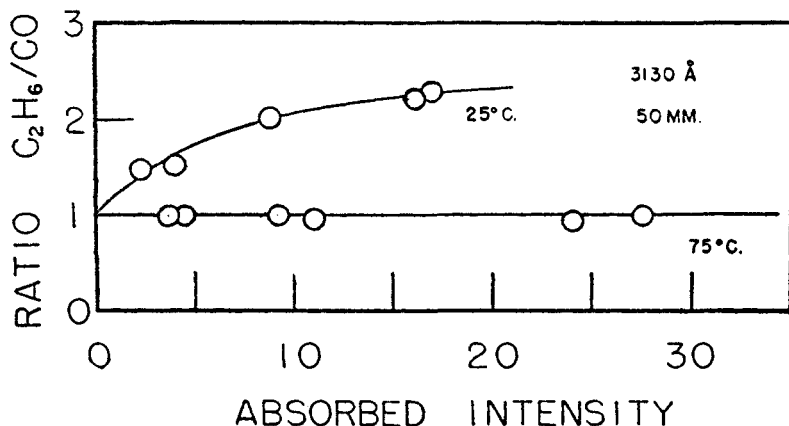

FIG. 3. Effect of absorbed intensity and temperature on C₂H₆/CO ratio at 3130 Å. (Herr and Noyes (36).)

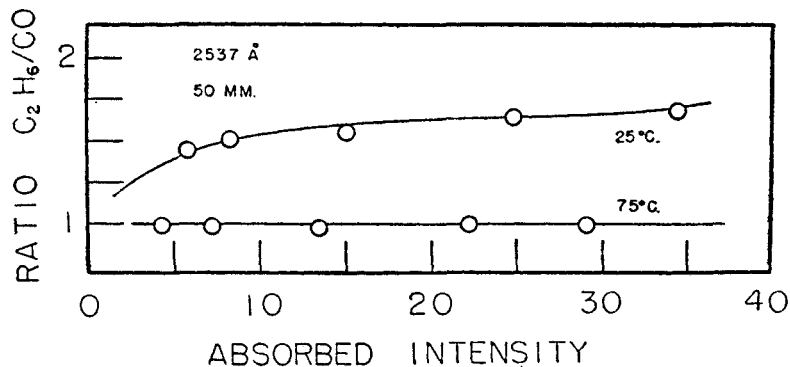
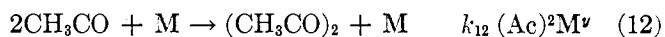

FIG. 4. Effect of absorbed intensity and temperature on C₂H₆/CO ratio at 2537 Å. (Herr and Noyes (36).)

Although reactions 1 and 4–11 explain most of the experimental data obtained from the photolysis of acetone at room temperature with either “banded” light around 3100 Å. or continuum light from 3000 Å. to 2200 Å., a few other reactions appear to be necessary in considerations of the effects of absorbed intensity and cell size.

For a given pressure at 25°C. the equations so far considered will not explain the experimentally observed increase in the C₂H₆/CO ratio with absorbed intensity (36). The increase in the biacetyl production, a parallel effect, can only

be explained if this product can be formed homogeneously at 3130 Å. or in the 2200–3000 Å. continuum.



or

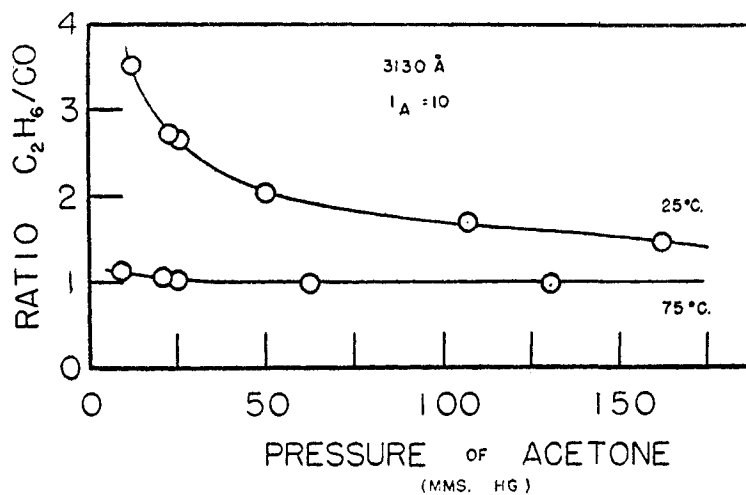

FIG. 5. Effect of pressure and temperature on C₂H₆/CO ratio at 3130 Å. (Herr and Noyes (36).)

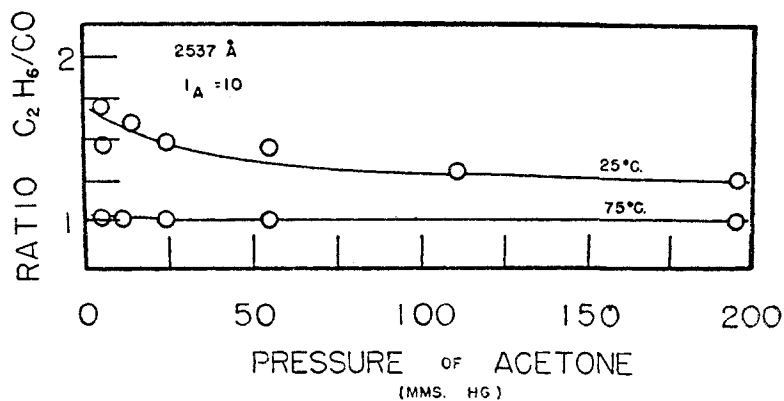

FIG. 6. Effect of pressure and temperature on C₂H₆/CO ratio at 2537 Å. (Herr and Noyes (36).)

That either reaction 12 or 11' is important is shown in figures 5 and 6. At pressures of 150 mm. of acetone the biacetyl yield has not decreased to zero, or the ratio C₂H₆/CO has not decreased to unity. These data are for moderate absorbed intensities.

At higher intensities, the equations so far considered appear to be in agreement with the experimental results. Studies on the reactions of the acetyl radical carried out by Anderson and Rollefson (6) using 2537 Å. radiation, with intensities about one hundred times those used by Noyes *et al.*, have shed considerable light on this subject. The reactions of the acetyl radical in the presence of biacetyl are dissociation to methyl and carbon monoxide or recombination. If one of these reactions were homogeneous and the other heterogeneous, the presence of considerable quantities of nitrogen would effect a change in the carbon monoxide yield. That this is not the case is shown in table 2. Hence, the formation of biacetyl at high intensities and moderate pressures and the decomposition of the acetyl radical must both be either homogeneous or heterogeneous. Since reaction 6 or 7 has been shown to occur mainly in the gas phase, the formation of biacetyl at high intensities must be homogeneous also, to a large extent. These considerations, of course, do not rule out heterogeneous reactions at low pressures.

TABLE 2
Reactions of the acetyl radical
 Biacetyl; 25°C.; time of run, 20 min.
 (Anderson and Rollefson (6))

Initial (CH ₃ CO) ₂ (moles × 10 ⁶).....	6.88	6.95
Initial N ₂ (moles × 10 ⁶).....	0	26.42
ΔP/P _i per cent.....	32.9	29.8
Products (moles × 10 ⁶):		
CO.....	2.41	2.37
CH ₄	0.07	
C ₂ H ₆	0.69	0.61
CO yield.....	0.351	0.341

Spence and Wild (71, 72) have shown that much of the above mechanism must be correct. These authors (71) found that the C₂H₆/CO ratio increases with rate of decomposition of acetone at low rates of decomposition, in agreement with equation 12 or 11'. As the intensity is further increased, the ratio apparently passes through a maximum value for banded absorption and then decreases somewhat.

An explanation of this maximum comes from consideration of equations 1, 5, 6, 8, 9', and 11':

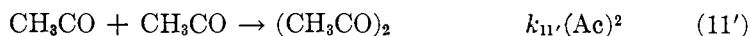
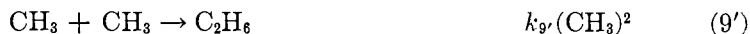
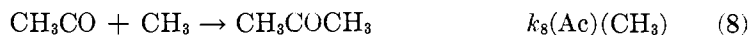
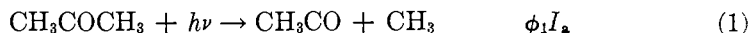

At high intensities and high pressures (>100 mm.), diffusion being relatively unimportant, these reactions can be used to explain most of the data.

From steady-state considerations:

$$\phi_1 I_a (1 - \alpha) = k_6(\text{Ac}) + k_8(\text{Ac})(\text{CH}_3) + k_{11}(\text{Ac})^2$$

$$\phi_1 I_a (1 + \alpha) = -k_6(\text{Ac}) + k_8(\text{Ac})(\text{CH}_3) + k_9(\text{CH}_3)^2$$

From this

$$(\text{Ac}) = \frac{-(k_8(\text{CH}_3) + k_6) + \{(k_8(\text{CH}_3) + k_6)^2 + 4k_{11}(1 - \alpha)\phi_1 I_a\}^{\frac{1}{2}}}{2k_{11}}$$

$$\frac{d(\text{C}_2\text{H}_6)}{dt} = \frac{k_9(\text{CH}_3)^2}{2}$$

$$\frac{d(\text{CO})}{dt} = k_6(\text{Ac}) + \alpha\phi_1 I_a$$

$$\frac{d(\text{C}_2\text{H}_6)}{d(\text{CO})} = \frac{k_9(\text{CH}_3)^2}{2\{k_6(\text{Ac}) + \alpha\phi_1 I_a\}}$$

Now

$$(\text{CH}_3) = \frac{-k_8(\text{Ac}) + [k_8^2(\text{Ac})^2 + 4k_9\{k_6(\text{Ac}) + \phi_1 I_a(1 + \alpha)\}]^{\frac{1}{2}}}{2k_9}$$

Then

$$\frac{d(\text{C}_2\text{H}_6)}{d(\text{CO})} = \frac{\{-k_8(\text{Ac}) + [k_8^2(\text{Ac})^2 + 4k_9\{k_6(\text{Ac}) + \phi_1 I_a(1 + \alpha)\}]^{\frac{1}{2}}\}^2}{8k_9\{k_6(\text{Ac}) + \alpha\phi_1 I_a\}}$$

If we use as a first approximation $(\text{Ac}) = KI_a$ at high intensities

$$\frac{d(\text{C}_2\text{H}_6)}{d(\text{CO})} = \frac{\{-k_8KI_a + [k_8^2K^2I_a^2 + 4k_9\{k_6KI_a + \phi_1 I_a(1 + \alpha)\}]^{\frac{1}{2}}\}^2}{8k_9\{k_6KI_a + \alpha\phi_1 I_a\}}$$

let

$$-k_8K = C_1; \quad 4k_9\{k_6K + \phi_1(1 + \alpha)\} = C_2$$

$$8k_9(k_6K + \alpha\phi_1) = C_3$$

$$\frac{d(\text{C}_2\text{H}_6)}{d(\text{CO})} = \frac{[C_1 I_a + \{C_1^2 I_a^2 + C_2 I_a\}^{\frac{1}{2}}]^2}{C_3 I_a}$$

$$\begin{aligned} \frac{d}{dI} \left(\frac{d(\text{C}_2\text{H}_6)}{d(\text{CO})} \right) &= \frac{d}{dI} \left[\frac{2C_1^2 I_a}{C_3} + \frac{2C_1}{C_3} \{C_1^2 I_a^2 + C_2 I_a\}^{\frac{1}{2}} + C_2 \right] \\ &= \frac{2C_1^2}{C_3} + \frac{C_1}{C_3} \frac{2C_1^2 I_a + C_2}{(C_1^2 I_a^2 + C_2 I_a)^{\frac{1}{2}}} \end{aligned}$$

For large values of I_a ; i.e., $I_a \ll I_a^2$

$$\frac{d}{dI} \left(\frac{d(\text{C}_2\text{H}_6)}{d(\text{CO})} \right) \simeq \frac{4C_1^2}{C_3} + \frac{C_2}{C_3 I_a}$$

Thus, at very high values of the absorbed intensity, the ratio $d(\text{C}_2\text{H}_6)/d(\text{CO})$, or $(\text{C}_2\text{H}_6)/(\text{CO})$, appears as a decreasing function of the intensity (see table 3). Although the assumption that for high intensities $(\text{Ac}) = KI_a$ is only approximate, it is probably close enough to allow the above reasoning a considerable validity.

TABLE 3
Influence of intensity on C₂H₆/CO ratio
 Full mercury arc
 (Spence and Wild (71))

ACETONE PRESSURE	TEMPERATURE	TIME	SCREEN TRANSMISSION	ACETONE DECOMPOSED		C ₂ H ₆ /CO
				Per cent	Yield per 10 hr. (cc. at N.T.P.)	
<i>mm.</i>	<i>°C.</i>	<i>hr.</i>	<i>per cent</i>			
163	22.0	17	100	30.7	2.81	1.62
163	19.5	2.5	100	4.2	2.60	1.62
164	20.5	3	100	6.0	3.13	1.59
162	21.0	19	60	17.4	1.42	1.76
165	20.5	15	40	9.7	1.01	1.84
161	21.0	24	18	7.7	0.49	1.98
161	20.0	48	7	5.6	0.19	1.87
164	19.0	67	2.5	2.8	0.066	1.56

TABLE 4
Photodecomposition in the region of continuous absorption. Influence of light intensity and acetone pressure
 (Spence and Wild (71))

ACETONE PRESSURE	TEMPERATURE	TIME	SCREEN TRANSMISSION	ACETONE DECOMPOSED		C ₂ H ₆ /CO	(P ^{1/4})
				Per cent	Yield per 10 hr. (cc. at N.T.P.)		
<i>mm.</i>	<i>°C.</i>	<i>hr.</i>	<i>per cent</i>				
160	20.0	48	100	43	1.37	2.44	(2.42)
160	19.5	21.5	100	16.9	1.19	2.44	(2.42)
161	21.0	17	100	16.2	1.46	2.47	(2.42)
160	20.0	21	60	9.3	0.68	2.18	
160	21.0	25.5	29	5.2	0.31	2.23	
160	20.0	41	12	3.1	0.115	1.87	
160	21.0	48	12	2.5	0.079	1.63	
70	20.0	24	100	21.6	0.598	1.94	(1.97)
70	20.0	18	100	19.4	0.719	1.92	(1.97)
32	20.0	26	100	31.1	0.367	1.62	(1.62)

Spence and Wilde (71, 72) also found the C₂H₆/CO ratio to increase with pressure at high intensities in the region of continuous absorption (see table 4).

Their data are in agreement with equation 12 or 11'; that is, at high intensities, the homogeneous formation of biacetyl becomes increasingly important as the pressure increases. If reaction 12 is used to explain the data of Spence and

Wild (71), the exponent y must be considerably less than 0.5. In the absence of any other effects, a value of 0.25 for y fits the data quite well.

The effects of high pressures of foreign gases upon the photolysis of acetone at 18–20°C. have been studied by Iredale and Lyons (40) at 2400–3100 Å. (see table 5). These studies show that at very high pressures biacetyl ceases to be formed, the ratio C_2H_6/CO becoming unity. Thus, the homogeneous formation of biacetyl becomes of less importance than the decomposition of the acetyl radicals or the re-formation of acetone.

Spence and Wild (71, 72) have proposed a mechanism involving long-lived excited acetone molecules to explain their data for decomposition in the banded absorption region. These authors have considered the following sequence of

TABLE 5
Effects of high pressures of foreign gases upon the photolysis of acetone
 $T = 18\text{--}20^\circ\text{C.}$

(Iredale and Lyons (40))

ADDED GAS	PRESSURE OF ADDED GAS	PRESSURE OF ACETONE	BIACETYL FORMED
	<i>mm.</i>	<i>mm.</i>	<i>mg.</i>
		150	2.0
		155	2.0
		140	2.0
CO ₂	620	150	0
CO ₂	590	150	0
N ₂	600	150	0
N ₂	640	140	0
N ₂	640	150	0

reactions for absorption of light around 3100 Å., and consider them to occur simultaneously with some of the radical reactions.

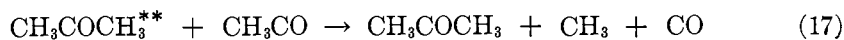
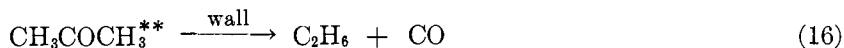
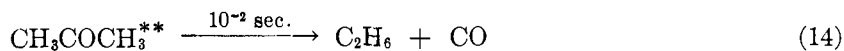
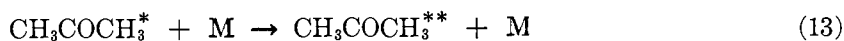
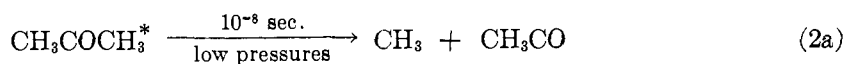
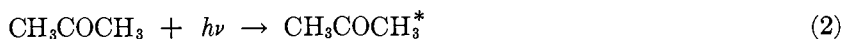

Reactions 13–15 are the most important at high acetone pressures.

Probably the easiest way to present the foundations of these reactions is to use exactly the arguments of Spence and Wild (72). These authors considered four effects which they believed could not be explained on the basis of the free-radical mechanism for acetone decomposition in the banded region.

(a) At constant I_a , the quantum yield and C_2H_6/CO ratio decrease with increase of pressure. This effect is much more pronounced than in the short-wave region and the data suggest that the quantum yield approaches unity as $P \rightarrow 0$.

(b) At constant pressure, the quantum yield is independent of I_a , in contrast to its behavior in the "continuum" region. On the other hand, the C_2H_6/CO ratio increases with increase of intensity as in the "continuum" region.

(c) Influence of the wall: At moderate pressures (160 mm.), a reduction in the mean molecular distance from the wall by the use of narrower vessels causes C_2H_6/CO to decrease toward unity. This effect would also be expected to become noticeable when the pressure is reduced in any given vessel, but actually, the ratio increases rapidly with fall of pressure.

(d) Effect of mixed light: At high intensities, the C_2H_6/CO value obtained with "continuum" light alone is reduced by the presence of light in the banded region to an extent which is considerably greater than would be expected on a purely additive basis (71).

Almy *et al.* (3, 4, 5) have shown that the energy of fluorescence of biacetyl must have been imparted to the biacetyl by energy transfer; that is, biacetyl is excited by collisions of the second kind. Although Almy *et al.* state that their data do not allow them to postulate a unique method of energy transfer, it is possible that the collision of the second kind involves excited acetone molecules and normal biacetyl molecules.

The work of Herr and Noyes (36) indicates that at acetone pressures of 160 mm., biacetyl production is very important when the photolysis is performed using 3130 Å. light. The intensity of biacetyl fluorescence increases with time (3) and becomes measurable a few seconds after the start of illumination. Since the partial pressure of biacetyl that can be built up after a few seconds' illumination must be extremely small, if excited acetone molecules are the source of the energy transferred to biacetyl, it follows that the former must be relatively long-lived. Spence and Wild (72) consider this consistent with their data for mixed light (condition *d*) and with the influence of diameter at high pressures.

The diameter effect³ seems to be open to considerable question. In their

³ Determination of the mean distance of molecules from the walls of a cylindrical cell with plane, parallel windows.

For simplicity we divide cells into two categories: (1) $l/2 \geq a$; (2) $l/2 \leq a$. In both cases we consider the distance to the nearest wall and require that all parts of the volume element be the same distance from the nearest wall.

Case 1. $l/2 \geq a$:

c = concentration in arbitrary units, and
 \bar{d} = mean, or average, molecular distance.

earlier work Spence and Wild (71) used a cylindrical cell of about 3.6 cm. inside diameter. As the mean displacement of molecules from the wall these authors used a value of 0.6 cm., i.e., one-third the radius. Assuming that the 7 cm. length of the cell would allow it to be called a long cell, this value would be correct. More accurately $d = 0.52$ cm. The annular cell, 1 cm. between walls,

(Footnote 3—continued)

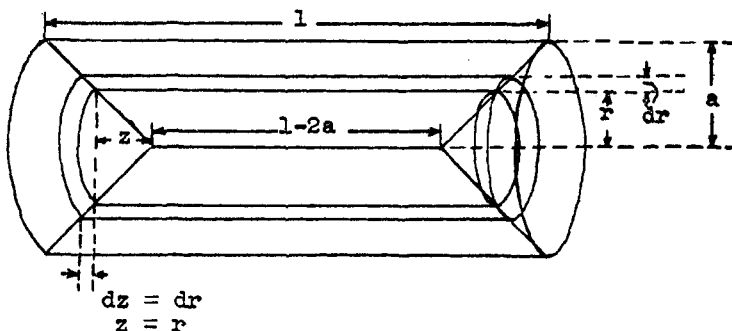

$$dN = cdV = 2\pi c\{r(l - 2a + 2r) + r^2\} dr$$

The distance to the nearest wall is $(a - r)$

$$d = \frac{2\pi c \int_0^a \{r(l - 2a + 2r) + r^2\} (a - r) dr}{\pi a^2 lc}$$

$$= \frac{2 \int_0^a \{-3r^3 + r^2(5a - l) + r(la - 2a^2)\} dr}{a^2 l}$$

$$= \frac{\left[-\frac{3r^4}{2} + \frac{2r^3}{3} (5a - l) + r^2(la - 2a^2) \right]_0^a}{a^2 l}$$

$$d = -\frac{a^2}{6l} + \frac{a}{3} \quad \text{as } l \rightarrow \infty, \quad d \rightarrow \frac{a}{3}$$

$$\frac{l}{2} = a, \quad d = \frac{l}{8} = \frac{a}{4}$$

Case 2. $l/2 \leq a$:

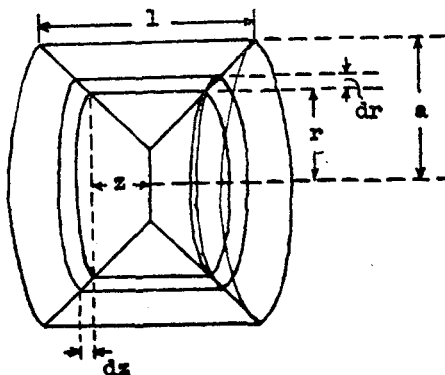

used in the later work (72) had a mean displacement of 0.25 cm. In using the data of Herr and Noyes (36), Spence and Wild used a value of the mean displacement of 1 cm. (1.2 cm. radius cell) instead of about 0.39. Therefore, the low values of C_2H_6/CO obtained by Spence and Wild (71, 72) with cells of mean displacement of 0.25 and 0.52 cm., are very much lower than those obtained by Herr and Noyes, at the same pressure and intensity, in a cell of intermediate mean displacement of 0.39 cm. The ratios obtained by Herr and Noyes (36) were checked quite closely by Howland and Noyes (39), using a cell the same size as that used by the former authors. Also, using a cell of 2.2 cm. inside diameter and 1 cm. long (mean displacement 0.18 cm.), Howland and Noyes found the diameter effect to be small, but in the opposite direction to that found by Spence and Wild, i.e., Howland and Noyes found that the ratio C_2H_6/CO increased as the mean displacement decreased.

A possible explanation of part or all of the difference in the C_2H_6/CO ratio

(Footnote 3—continued)

Here $r = a - 2 + z$.

$$dN = \pi c \left\{ \left(a - \frac{l}{2} + z \right)^2 + 2 \left(a - \frac{l}{2} + z \right) z \right\} dz$$

$$d = \frac{2\pi c \int_0^{l/2} \left\{ \left(a - \frac{l}{2} + z \right)^2 + 2 \left(a - \frac{l}{2} + z \right) z \right\} dz}{\pi c a^2 l}$$

$$d = \frac{l^3 - 8l^2 a + 24a^2 l}{96a^2}$$

$$\text{as } a \rightarrow \infty \quad d \rightarrow l/4$$

$$a = \frac{l}{2} \quad d = \frac{l}{8} = \frac{a}{4}$$

The cell used by Spence and Wild (71) had dimensions $l = 7$ cm. and $a = 1.8$ cm. This cell is analyzed according to *Case 1*: i.e., $l/2 > a$.

$$d = \frac{-a^2}{6l} + \frac{a}{3} = -0.08 + 0.6 = 0.52 \text{ cm.}$$

The cell used by Herr and Noyes (36) had dimensions $l = 20$ cm. and $a = 1.1 - 1.2$ cm. Here, also

$$d = \frac{-a^2}{6l} + \frac{a}{3}; \quad d = 0.36 \text{ cm. for } a = 1.1 \text{ cm.}$$

$$d = 0.39 \text{ cm. for } a = 1.2 \text{ cm.}$$

The cell used by Spence and Wild (72) was of annular construction, with 1 cm. between walls. This cell is analyzed according to *Case 2*, with $a \approx l$. The cell was 10 cm. long ($a = 10, l = 1$).

$$d = \frac{l^3 - 8l^2 a + 24a^2 l}{96a^2} = 0.25$$

The short cell used by Howland and Noyes (39) also is analyzed according to *Case 2*, with $l = 1$ cm., $a = 1.1$ cm.

$$d = 0.18 \text{ cm.}$$

found by Spence and Wild (71, 72) and by Noyes *et al.* (36, 39) may come from an examination of the light sources used. For banded absorption experiments Noyes *et al.* used approximately monochromatic light, the main impurity being due to the pressure broadening of the 3130 Å. group in the medium-pressure quartz-jacketed mercury arcs. Spence and Wild (71) used one of three filters to remove continuum radiation: Pyrex, potassium biphthalate, potassium chromate. Only the latter filter removes 3347 and 3660 Å. radiation to a large extent, and only when this filter was used was a value of C_2H_6/CO greater than unity obtained. Biacetyl might decompose either by absorption of wave lengths 3347 and 3660 Å. or by collision of the second kind with acetone (see above). The ratio C_2H_6/CO from acetone would be much more nearly unity than either with small percentage decomposition or in a flow system where the biacetyl is removed. This effect would be much more pronounced when the continuum light is removed, since then the 3660 Å. radiation constitutes a much larger per cent of the total incident intensity.

The effect of increase of pressure on quantum yield and C_2H_6/CO (condition *a*) could not be explained on the basis of an excited acetone molecule of mean life 10^{-2} sec., a figure determined by Spence and Wild (72) from the above data. If the effect were due to deactivation of an excited molecule by collisions, such as we have in unimolecular reactions, a life-period of about 10^{-8} sec. would be expected. Spence and Wild consider that the widely different requirements for excited acetone molecules are met by the two excited states. The reactions of the excited state of life-period 10^{-8} sec. are given by reaction 2a (low pressure) and by reaction 13 (high pressure). The reactions of the long-life excited molecules are given in equations 14-17.

On the basis of a purely free-radical mechanism, the effect of increase of pressure on quantum yield and C_2H_6/CO is readily explained by the homogeneous reactions 6 or 7 (increased dissociation of acetyl leads to a smaller value of C_2H_6/CO); the recombination reaction 8; the decreasing importance of 11 with increase of pressure and the smaller increase of the importance of reactions 11 and 12.

The Spence and Wild theory (72) offers an explanation of the decrease of the C_2H_6/CO ratio with decreasing wave length that differs from the free-radical explanation. The latter theory considers the increased energy retained by the acetyl radicals after dissociation. As this energy increases (decreasing wave length) the spontaneous decomposition must increase, leading to smaller values of C_2H_6/CO . The Spence and Wild view is that the excess vibrational energy possessed by the acetyl radicals would be rapidly dissipated by collision at high pressures, but with decrease of pressure a growing proportion would decompose spontaneously. In consequence, the concentration of acetyl radicals, and therefore the value of C_2H_6/CO , would be less in the "continuum" region than in the "banded" region at low pressures.

As regards the effect of mixed light (condition *d*), the Spence and Wild view is that excited acetone molecules of long life produced in the banded region bring about the decomposition of acetyl radicals produced in the continuum (reaction 17).

On the basis of any theory the explanation of the changes of experimental quantities (ethane, carbon monoxide, etc.) with increasing polychromatic character of the light source must be very difficult at best. Certainly the products formed by irradiation with any two different mercury arcs, unfiltered, would be different if the spectral distributions were different. Because of this, and because of chromatic aberration effects, it is nearly impossible to account quantitatively for the effect of mixed light.

The results of the Spence and Wild mechanism, which includes the reactions 1, 7, 8, 9', 10, 11' as radical steps plus the excited molecule steps 2, 2a, 13-17 is given graphically by these authors, the relative importance of the two mechanisms being plotted as functions of acetone pressure.

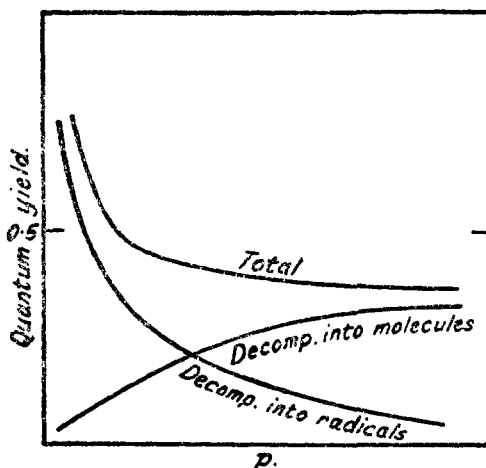
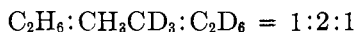

FIG. 7. Variation of quantum yield of photodecomposition of acetone with pressure in the banded region (qualitative). (Spence and Wild (72).)

The experimental data on the photolysis of acetone at 3130 Å., the "banded" region, contradict one of the theories (free radical or excited acetone) to some extent, if the light used by Spence and Wild (71, 72) can be considered to consist of radiation between the limit 3050 Å. and 3300 Å. This point, as noted above, seems doubtful. As a result it seems that the excited-molecule theory requires more conclusive proof (the diameter effect) before it can be accepted. The data of Noyes *et al.* (36, 39) cannot be explained by the Spence and Wild theory.

One possible method of differentiation between the two theories, besides further studies on the diameter effect using nearly monochromatic 3130 Å. radiation, would be to photolyze CH_3COCH_3 in the presence of CD_3COCD_3 . Such studies would shed considerable information on the reactions by which ethane is formed. If this is formed by a non-radical mechanism under any conditions, C_2H_6 and C_2D_6 would be formed to a greater extent than would be expected upon the basis of a free-radical mechanism, which would predict, approximately:



At pressures in the order of 150 mm. of acetone, or higher, the Spence and Wild mechanism would predict this ratio to be of the order 1:1:1, quite different from the predictions of the purely free-radical mechanism. Further, the acetone remaining after illumination should be a mixture of CH_3COCH_3 , CH_3COCD_3 , and CD_3COCD_3 if the free-radical mechanism is obeyed; i.e., if the low quantum yield of acetone decomposition is due to radical recombination.

Before discussing the effect of temperature upon the products of the photolysis of acetone, it might be well to consider some recent work of Feldman, Burton, Ricci, and Davis (24). The excited-molecule mechanism was presented by Spence and Wild to account for the results of the photolysis of acetone only in the "banded" region of absorption above about 3050 Å. Below this wave length, that is, in the region of continuous absorption, these authors, in agreement with others, had considered that only the free-radical mechanism was necessary to explain the experimental data. As a result of their experiments on the flow photolysis of acetone using 2537 Å. radiation, Feldman, Burton, Ricci, and Davis now consider that the Spence and Wild mechanism must be active in this region also. This conclusion was reached as a result of the formation of considerable quantities of ethane under conditions such that nearly all methyl radicals were expected to be removed by lead mirrors before these radicals could react to form ethane. If a quantum yield for carbon monoxide formation of about 0.2 is assumed for low pressures of acetone (2 mm.) at 2537 Å., the data of Feldman, Burton, Ricci, and Davis indicate an absorbed intensity of about 2×10^{15} quanta/sec., that is, intensities about twenty times greater than those used by Herr and Noyes (36), and of the same magnitude as used by Benson and Forbes (10). The work of Benson and Forbes (10), the flow photolysis in the absence or presence of iodine, shows no ethane formed at temperatures up to 140°C. when iodine is present. This is opposed to the data of Feldman, Burton, Ricci, and Davis, who found large amounts of ethane formed in the presence of another radical remover, the lead mirror. To reconcile these different results would be rather difficult and will not be attempted, but a few obvious conclusions can be drawn. Feldman, Burton, Ricci, and Davis have considered that, following reaction 2, reactions 2a and 13 occur. To explain their results, reaction 13 would have to predominate at low pressures, where, according to the Spence and Wild mechanism, reaction 2a predominates, at least at 3130 Å. Further, Feldman, Burton, Ricci, and Davis believe that in the presence of iodine, reaction 13 is followed by

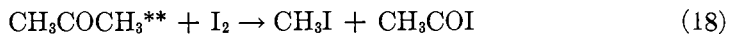

To explain the complete absence of ethane in the work of Benson and Forbes, reaction 18 would have to have an efficiency of about 100 per cent; i.e., to have occurred so rapidly that reactions 14 and 16, the ethane-forming reactions, are relatively unimportant.

Although Feldman, Burton, Ricci, and Davis reported methyl radicals, carbon monoxide, and ethane to be their main products, other authors, Benson and Forbes (10), Herr and Noyes (36), and Spence and Wild (71), have all found

biacetyl formed at 2537 Å. Benson and Forbes (10) reported a $(\text{CH}_3\text{CO})_2/\text{CO}$ ratio of 0.1–0.4 at 60°C., depending upon conditions, but apparently increasing with linear flow velocity. Thus, although Feldman, Burton, Ricci, and Davis reported no biacetyl, this must certainly have been formed in their experiments, especially at 0°C. If the analyses of Feldman, Burton, Ricci, and Davis for methyl, carbon monoxide, and ethane are assumed correct, the amount of biacetyl calculated from the material balance

$$\begin{aligned} N_{\text{acetone}} &= 2N_{\text{C}_2\text{H}_6} - N_{\text{CO}} \\ N_{\text{biacetyl}} &= N_{\text{C}_2\text{H}_6} - N_{\text{CO}} \\ \frac{1}{2}N_{\text{CH}_3} + n_{\text{C}_2\text{H}_6} &= N_{\text{C}_2\text{H}_6} \end{aligned} \quad (19)$$

$n_{\text{C}_2\text{H}_6}$ = cm.³ or mm.³ of ethane analyzed as such.

is always found to be a negative quantity of considerable magnitude at 0°C. and a positive quantity at other temperatures up to 100°C., with a few exceptions at 100°C. Further, although the average deviation from a correct material balance for all runs is only about 25 per cent, individual runs show errors of up to 85 per cent. If the ethane and carbon monoxide analyses are assumed to be correct, using equation 19, the error in the methyl determination appears to be enormous in the work of Feldman, Burton, Ricci, and Davis, the value of $\text{CH}_3(\text{missing})/\text{CH}_3(\text{found})$ varying from 3.5 to – 8.0.

Aside from these considerations of the work of Feldman, Burton, Ricci, and Davis, the Spence and Wild mechanism extended to continuum absorption (2200–3000 Å.) contradicts the work of Taylor and Rosenblum (74). Table 12 shows that in the presence of hydrogen the photolysis of acetone yields a value of $\text{CH}_4/\text{CO} \simeq 1$ at about 250°C. Since methane can presumably be formed only from the intermediate methyl radical, the above ratio requires a minimum of 50 per cent radical decomposition of acetone, allowing no formation of ethane from methyl. Further, at 300°C., $\text{CH}_4/\text{CO} \simeq 1.35$, here requiring a minimum of 68 per cent radical decomposition of acetone.

Considering the many questions that can be raised concerning the validity of the data of Feldman, Burton, Ricci, and Davis, it appears that this work cannot be considered of sufficient accuracy to warrant the discarding of the free-radical mechanism for the photolysis of acetone at 2537 Å. in favor of an extended Spence and Wild mechanism.

As in the case of photolysis in the “banded” region, it is quite probable that if the Spence and Wild mechanism is correct for “continuum” photolysis, this could be determined by a thorough study of the photodecomposition of ethyl methyl ketone. Here again, the Spence and Wild mechanism would require that $\text{C}_2\text{H}_6:\text{C}_3\text{H}_8:\text{C}_4\text{H}_{10}$ be considerably different from 1:1:1 if the hydrocarbon can be formed in one step. Also, the photolysis of mixed normal and deuterio acetones would yield data that would allow differentiation between the free-radical mechanism and the Spence and Wild mechanism, as will further determinations on the extent of methane and C_3 - and C_4 -hydrocarbon formation.

The effect of temperature upon the photolysis of acetone has been studied to a considerable extent. As previously mentioned, the formation of biacetyl becomes

TABLE 6
Experiments in unfiltered light on the stability of the acetyl radical and the formation of acetyl iodide
(Gorin (30))

PRESSURE OF ACETONE	INITIAL PRESSURE OF IODINE	CH ₃ I	CH ₃ COI	CO	TEMPERATURE
<i>mm.</i>	<i>mm.</i>	<i>moles × 10⁶</i>	<i>moles × 10⁶</i>	<i>moles × 10⁶</i>	<i>°C.</i>
165	4	21.7	9.3	1.62	100
487	2	43.0	4.0	2.67	100
430	4	29.4	8.8	5.28	115
156	2	36.8	4.6	5.82	115
517	4	14.6	7.0	4.96	128
169	2	41.6	3.4	15.02	130

TABLE 7
Photolysis of acetone, acetone-iodine mixtures at λ 2537 Å.
 $P_{\text{acetone}} = 12.0 \pm 0.2 \text{ mm. (0°C.)}$; $P_{\text{acetone}}/P_{\text{iodine}} = 54 \pm 2$
(Benson and Forbes (10))

RUN	TEMPERATURE	FLOW	CC. AT N.T.P.				IODIDES	CH ₄ CO	C ₂ H ₆ CO	(CH ₃ CO) ₂ CO
			CO	CH ₄	C ₂ H ₆	(CH ₃ CO) ₂				
	<i>°C.</i>	<i>cm./sec.</i>								
4	60.1	1.05	2.34	0.18	2.81	0.90		0.078	1.20	0.38
5*	60.0	?	2.11	0.061			?	0.029		
6	59.9	0.79	2.48	0.21	3.06	0.73		0.083	1.23	0.29
7*	59.9	0.53	2.09	0.036			5.42	0.017		
8	100.3	0.97	3.45	0.23	3.49	0.10		0.067	1.01	0.029
9*	100.5	0.88	1.38 (?)	0.021			3.60	0.015		
10	142	0.62	3.68	0.37	3.35	0.00		0.100	0.911	0.00
11*	142	0.67	2.03	0.029			4.26	0.014		
12	60.2	0.54	2.00	0.14	2.20	0.22		0.068	1.10	0.11
13*	60.2	0.65	1.68	0.022			4.46	0.013		
14*	102.0	0.63	1.84	0.038			4.16	0.020		
15	60.5	0.96	2.02	0.13	2.37	0.44		0.066	1.17	0.22

* Runs made with iodine present.
Time of runs = 90 min.

small at temperatures above 60–75°C. Gorin (30) has shown that the absence of biacetyl up to 100°C. may be due to the reaction

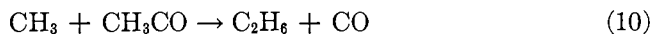

rather than to the increased importance of



although, as mentioned previously, reaction 6 is probably more important at higher temperatures than Gorin indicates. Some of the experimental details are missing from the paper of Gorin (30), so the sufficiency of the iodine present to react with all the methyl and acetyl formed might be questioned. However, in an earlier paper Gorin (28) stated that 0.2 mm. iodine was sufficient to react with all radicals formed. (For experimental details of Gorin's work see reference 29.) Using this, we would expect the 0.5 mm. iodine, the minimum amount reported used (30), to be sufficient. If reaction 6 became very important at 100°C., considerable amounts of carbon monoxide would be expected at this temperature, even in the presence of iodine. Gorin (30) and Benson and Forbes (10) found less carbon monoxide formed in the presence of iodine than in the absence, even up to temperatures of 140°C. (see tables 6 and 7). This is not opposed to the increasing importance of the thermal reaction (6).

The stability of the acetyl radical has also been demonstrated by Feldman, Ricci, and Burton (25) by the use of the mirror technique. Acetone was irradiated at 45°C. with 2537 Å. light, and after removal of methyl radicals by a first mirror, heating the flow tube gently caused the disappearance of a second mirror, probably by methyl radicals formed from the thermal decomposition of CH₃CO. The reduction in the relative amount of biacetyl above 60–75°C. has been attributed (30) to the reaction

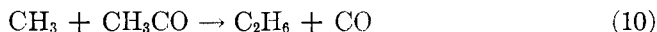

rather than to the instability of the acetyl radical. However, as explained above, biacetyl has been found (6) up to 110°C., so that pressure and intensity at this temperature, plus other reactions, determine whether or not biacetyl is formed.

Taylor and Jungers (73) suggested another reaction to explain the absence of biacetyl above about 75°C. and also partly to account for the low over-all yield of acetone decomposed at lower temperatures.



Herr, Matheson, and Walters (35) photolyzed acetone in the presence of (CD₃CO)₂ and found no deuterated ethane, such as CH₃CD₂. Since this latter product would be expected if reaction 20 occurred to an appreciable extent, its absence is strong evidence that reaction 20 does not occur, at least at the temperatures (below 60–75°C.) where biacetyl formation is favored.

Anderson and Rollefson (6) have actually reported the formation of biacetyl at temperatures as high as 110°C. (see table 8).

That the photochemical decomposition of acetone does not follow a chain process has been demonstrated by many workers. Leermakers (42) showed that the quantum yield for carbon monoxide formation does not exceed 1.3 even up to 400°C. Winkler (76) obtained essentially the same results as Leermakers, and also reported the formation of compounds not found when the photolysis occurs at room temperature. Thus, for 50 per cent decomposition of acetone at 60°C., Winkler found approximately 9 per cent methane, while at 400°C. 32 per cent methane was found, 5 per cent hydrogen, and some unsaturated compounds.

In the presence of nitric oxide, Mitchell and Hinshelwood (47) confirmed the

above, finding $\Phi_{\text{acetone}} = 1.1$ as the average of eight runs at 300°C. The only difference caused by the presence of nitric oxide was the formation of carbon dioxide.

At 75°C. Herr and Noyes found the quantum yield for carbon monoxide formation to rise from about 0.8 to 0.9 as the pressure of acetone was increased from about 5 to 150 mm., both at 3130 Å. and 2537 Å. at absorbed intensities of 5×10^{13} quanta per second (figures 2 and 3). However, the quantity was found to decrease with increasing intensity at 50 mm. pressure (36).

TABLE 8

Photolysis of acetone at 2537 Å.

Reaction cell 5.0 cm. in diameter, 5.5 cm. long; volume 113.5 cc. with 3.3 per cent dead space

(Anderson and Rollefson (6))

TEMPERATURE °C.	INITIAL (CH ₃) ₂ CO <i>moles</i> × 10 ⁵	PRODUCTS IN MOLES × 10 ⁵			
		CO	CH ₄	C ₂ H ₆	(CH ₃ CO) ₂
3	24.39	0.80	0.09	2.85	2.20
3.5	24.75	1.10	0.17	2.93	2.18
22	25.82	0.74	0.08	2.69	2.01
22.5	25.33	0.87	0.12	2.58	1.76
26.5	25.23	0.72	0.09	2.70	2.04
64.5	24.95	1.68	0.10	3.16	1.56
65.5	24.26	1.49	0.13	2.74	1.40
82	24.18	2.99	0.17	4.09	1.21
88	24.55	3.66	0.19	4.57	1.19
98	24.71	4.51	0.15	5.30	0.86
102	24.63	4.34	0.16	4.70	0.59
107.5	24.47	2.53	0.23	2.67	0.26
109.5	25.32	3.72	0.22	3.91	0.24
110	24.63	4.46	0.15	4.62	0.27
114.5	25.33	4.46	0.18	4.48	0.11
120.5	24.59	5.80	0.20	5.70	0
133	24.02	3.63	0.21	3.57	0
140	25.20	5.45	0.40	5.29	0

To get concentrations in moles per liter, multiply moles by 8.8.

That the quantum yields of carbon monoxide formation or acetone decomposition appear to approach unity at about 125°C. is shown in the work of Herr and Noyes (36).

The way in which the quantum yields of acetone decomposed or carbon monoxide formed decrease with intensity has not been studied very carefully. Thus, although these quantities approach unity at about 125°C., Akeroyd and Norrish (1) found values considerably less than unity when acetone is photolyzed using the full intensity of a mercury arc (see table 9).

Akeroyd and Norrish also reported the distribution of products shown in table 10 for the photolysis at 350°C.

At high intensities at 860 mm. acetone pressure Spence and Wild (71) found considerable amounts of methane even at 60°C. (see table 11).

Of course, runs at 860 mm., as mentioned by Spence and Wild, cannot be compared with runs say at 200 mm. or lower acetone pressure. Hence, these data are of use only in indicating that even at 60°C. methane may be formed at the lower pressures.

TABLE 9
Photolysis of acetone with full intensity of a mercury arc
 $P_{\text{acetone}} = 70 \text{ mm. when reduced to } 100^\circ\text{C.}$
 (Akeroyd and Norrish (1))

Temperature, °C.....	63	100	200	300	396
Mean Φ_{acetone}	0.3	0.47	0.5	0.65	0.76

TABLE 10
Photolysis of acetone at 350°C.
 Time of illumination = 284 min.
 (Akeroyd and Norrish (1))

Product.....	CO	CH ₄	C ₂ H ₆	Unsaturated	H ₂
cc. at N.T.P.....	1.0	0.8	0.4	0.15	0.1

TABLE 11
Photolysis of acetone at high intensities
 (Spence and Wild (71))

NO.	RADIATION	TIME	SCREEN TRANSMIS- SION	GASEOUS PRODUCTS			
				Volume at N.T.P.	CO	C ₂ H ₆	CH ₄
		<i>hr.</i>	<i>per cent</i>	<i>cc.</i>	<i>per cent</i>	<i>per cent</i>	<i>per cent</i>
24	Full arc	9.5	100	13.52	45.0	41.4	13.6
26	Continuum	24	100	4.15	48.3	33.3	18.4
27	Continuum	20	100	3.27	47.6	32.6	19.8
30	Continuum	24	29	1.54	52.6	19.6	27.8
28	Continuum	15	22	0.73	55.0	18.9	26.0
31	None	24		0.00			

Taylor and Rosenblum (74) have studied the effect of temperature upon the photolysis of acetone in the presence and absence of hydrogen (table 12). They found no increase in Φ_{CO} from 160° to 300°C. in the absence or presence of hydrogen, but the presence of hydrogen caused an increase in the methane yield and a decrease in the ethane yield.

The effect of hydrogen upon the ratios CH₄/CO and C₂H₆/CO is shown in table 13.

The values of C₂H₆/CO being greater than unity below 160°C. would suggest that below this temperature biacetyl is formed. From the lack of carbon

balance, determined by $(C_2H_6 + \frac{1}{2}CH_4)/CO$, it appears, as stated by Taylor and Rosenblum, that above $70^\circ C$. the hydrocarbons start to polymerize, this factor becoming quite important at $200^\circ C$.

TABLE 12
The photolysis of acetone in the presence and absence of hydrogen
Reaction volume, 131.4 cc.; full mercury arc; light below 2000 Å. removed
(Taylor and Rosenblum (74))

TEMPERATURE °C.	MOLES OF REACTANT × 10 ⁴		MOLES OF PRODUCTS × 10 ⁴					
	(CH ₃) ₂ CO	H ₂	(CH ₃) ₂ CO		CH ₄	CO	H ₂	C—C
			By differ- ence	Measured				
71	2.52		0.81	0.72	0.109	1.305		1.524
71	2.57	12.85	0.87	0.82	0.101	1.383	12.79	1.512
160	2.52		1.07	1.01	0.079	1.377		1.352
160	2.55	12.74	0.90	0.86	0.423	1.582	12.61	1.353
200	2.49	12.44	0.88	0.83	0.933	1.592	12.11	0.949
250	2.52		0.76	0.71	0.463	1.753		1.213
250	2.50	12.49	0.95	0.89	1.57	1.51	11.96	0.482
300	2.49		0.86	0.71	0.802	1.513		0.863*
300	2.54	12.69	0.77	0.72	2.327	1.728	11.69	0.378

* This value may be high by 8 per cent, which would yield for the final acetone values approximately 0.92 by difference and approximately 0.77 measured.

TABLE 13
Effect of hydrogen upon the CH₄/CO and C₂H₆/CO ratios
(Taylor and Rosenblum (74))

TEMPERATURE °C.	C ₂ H ₆ /CO		CH ₄ /CO		$\frac{2(-\Delta H_2)}{CO}$	$\frac{C_2H_6 + 1/2 CH_4}{CO}$	
	H ₂ absent	H ₂ present	H ₂ absent	H ₂ present		H ₂ absent	H ₂ present
71	1.17	1.09	0.083	0.073	0.087	1.21	1.13
160	0.982	0.855	0.057	0.268	0.164	1.01	0.99
200	(0.86)*	0.595	(0.11)*	0.585	0.414	(0.91)*	0.89
250	0.692	0.319	0.264	1.04	0.702	0.82	0.84
300	0.570	0.219	0.530	1.35	1.16	0.83	0.89

* Interpolated values.

In the presence of hydrogen the formation of methane can easily be explained by reaction 21:



Taylor and Rosenblum determined an energy of activation of 11 ± 2 kg.-cal. for this reaction.

The method of formation of methane in the absence of hydrogen has generally been taken to be that listed by Rice and Herzfeld (65):

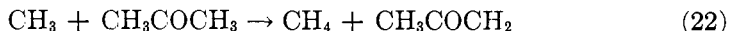

The energy of activation of this reaction has been given as about 15 kg.-cal. (14, 65).

A reaction to be expected as a consequence of reaction 22 would lead to the formation of ethyl methyl ketone as well as ketene.

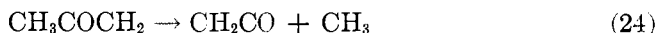

Reaction 23 has been assigned an energy of activation of about 8 kg.-cal. (14), while the 48 kg.-cal. energy of activation of reaction 24 (14) suggests that the formation of ketene will be unimportant except at temperatures above 400°C.

Saunders and Taylor (69) have carried out a very extensive study on the effects of mercury and dimethylmercury upon the photolysis of acetone at temperatures from 100° to 275°C. The data given by these authors are so extensive that they are best represented graphically. In general, below about 100°C. it appears that mercury and even dimethylmercury have very little effect upon the products. However, above about 150°C. the presence of these substances is seen from figure 8 to cause a decrease in the amounts of carbon monoxide and ethane formed and an increase in the amount of methane formed.

Saunders and Taylor also found the carbon deficiency, or the amount of hydrocarbons with more than three carbon atoms, to be a function of mercury and dimethylmercury as well as of temperature (see figure 9). Thus, these substances have an effect upon the polymerization of the lower hydrocarbons.

Most of the reactions considered by Saunders and Taylor for the photolysis of acetone in the absence of mercury and dimethylmercury are those already considered, namely:

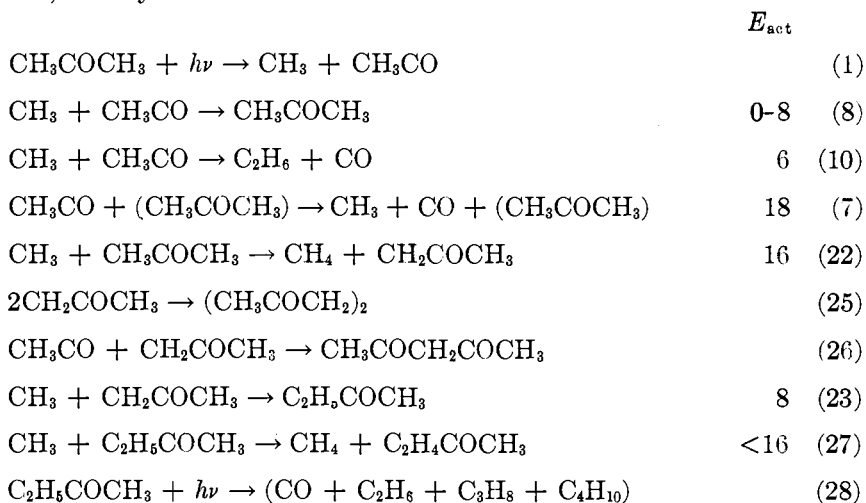

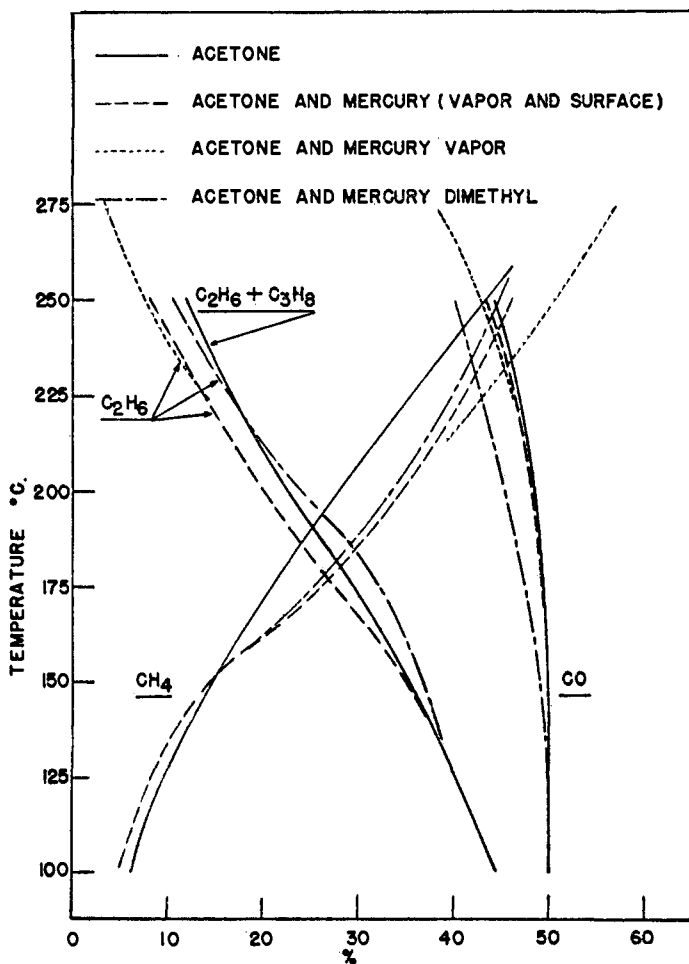
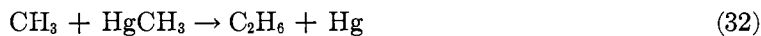
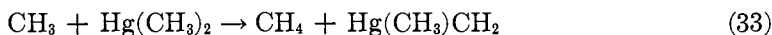

FIG. 8. Effect of temperature on the products of the decomposition of acetone. (Saunders and Taylor (69).)

In the presence of mercury, Saunders and Taylor have presented the following additional equations:



Additional reactions suggested for dimethylmercury are:



Saunders and Taylor have used equation 10 to explain the presence of ethane rather than equation 6 or 7. This use may be justified, since the pressures used were about 25 to 200 mm. at relatively high intensities, but the thermal reaction (reaction 6) certainly is very important above 150°C. At the lower pressures equation 6 or 7 also should be considered.

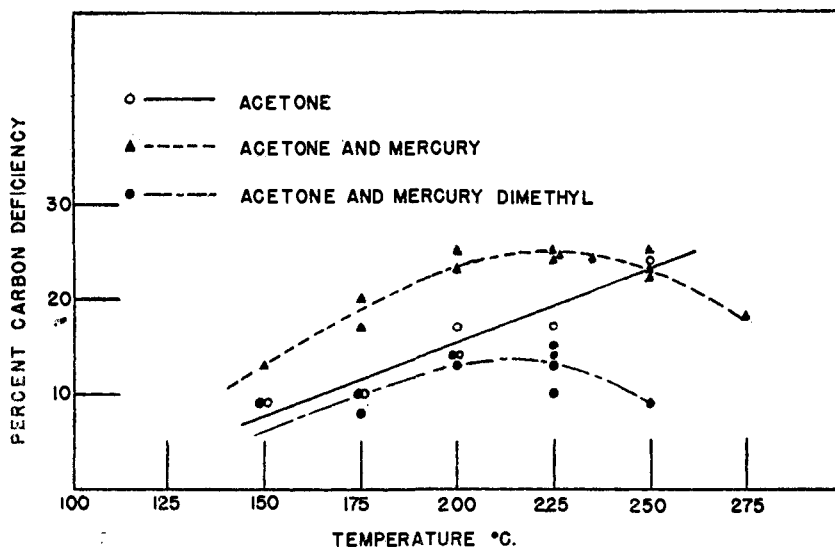

FIG. 9. Per cent carbon deficiency as a function of temperature. (Saunders and Taylor (69).)

Two conclusions drawn by Saunders and Taylor (69) are of interest, namely:

$$\frac{\text{CH}_4}{\text{CO}} \propto (P_{\text{acetone}})^{2/3} \quad (35)$$

and

$$\frac{\text{C}_2\text{H}_6}{\text{CO}} \propto \left(\frac{1}{P_{\text{acetone}}} \right)^{1/3} \quad (36)$$

A few last points on the photolysis of acetone at higher pressures need mentioning. Roof and Blacet (67) have pointed out that at temperatures not much above 100°C. the acetyl radical decomposes nearly to the extent of 100 per cent according to reaction 6 or 7. This is not in disagreement with previous statements that at 100°C. 60-90 per cent of the acetyl radicals decompose. Thus, the formation of ethane can result nearly solely from the combination of two methyl radicals. At high pressures, either of acetone or of foreign gases, the diffusion of methyl radicals to the walls would be very slow, and, hence, if wall formation of ethane were the only way in which this compound could be formed, under these conditions we would expect homogeneous reactions such as 22 to predominate, the rate of ethane formation being low. However, Grahame and

Rollefson (32) have obtained evidence that ethane is formed by the rather accurately bimolecular reaction:



At high temperatures and pressures ethane possibly results solely according to equation 9'.

Studies by Danby and Hinshelwood (17) on the polymerization of olefins induced by free radicals at 300°C. have led these authors to conclude that acetone

TABLE 14
Polymerization of olefins by free radicals at 300°C.
(Danby and Hinshelwood (17))

	I_a (ARBITRARY UNITS)
50 mm. CH_3CHO	9.9
25 mm. CH_3COCH_3	5.1
50 mm. CH_3COCH_3	8.4
25 mm. $\text{C}_2\text{H}_5\text{COC}_2\text{H}_5$	5.8

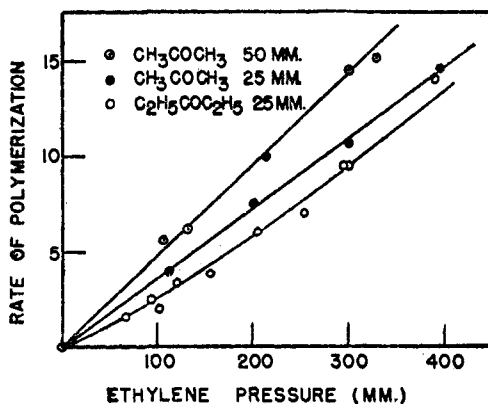

FIG. 10. Polymerization of ethylene induced by photolysis of dimethyl and diethyl ketones. (Danby and Hinshelwood (17).)

is only 69 per cent as effective in producing free radicals at this temperature as is acetaldehyde (table 14; figure 10). In this work the full radiation of the mercury arc was used. The rate of the induced polymerization, σ , was calculated from the equation

$$\sigma = nk_{38}[\text{C}_2\text{H}_4] \sqrt{\frac{k_1 I_a}{k_9}} \quad (37)$$

where



Since polychromatic light was used in these experiments, the ratio of the rates of polymerization induced by acetone and acetaldehyde is necessarily some sort of average over wave lengths from about 1800 A. (the lower transmission wave length of quartz) to about 3300 A.

Grahame and Rollefson (32) have made similar comparisons on the relative rates of radical production by acetone and acetaldehyde during studies on the high-temperature chain decomposition of acetaldehyde (table 15).

The value of 0.70 obtained for acetone at 3130 A. by Grahame and Rollefson is in good absolute agreement with that obtained by Gorin (30) for the photolysis of acetone at 90°C. in the presence of iodine (see table 16).

TABLE 15
Relative quantum efficiencies for the primary photochemical processes in the dissociation of acetone and acetaldehyde into free radicals at elevated temperatures
(Grahame and Rollefson (32))

λ	ACETALDEHYDE	ACETONE
A.		
3130	1.00	0.70
2652	0.55	0.92

TABLE 16
Photolysis of acetone, acetone-iodine mixtures
Experiments in filtered light; $\lambda = 3130$ A.
(Gorin (30))

EXPT.	PRESSURE OF ACETONE	PRESSURE OF IODINE	TEMPERATURE	CH ₂ I	CO	TIME	CH ₄
	mm.	mm.	°C.	moles $\times 10^4$	moles $\times 10^4$	min.	
1	852	1	90	5.67		120	0.85
2	852	0	80		1.13	120	
3	1265	0.5	90	8.76		120	0.78
4	1265	0	80		1.90	120	

That hydrocarbons at least as high as butane can be formed in the high-temperature photolysis of acetone has been demonstrated by Allen (2). Experiments were run using an unfiltered, high-intensity mercury arc, with about 50 per cent of the acetone decomposed. Besides methane, Podbelniak distillation analyses showed the presence of propylene, propane, and butane (normal and iso).

An accurate determination of the mechanism of the acetone photolysis above about 300°C. is rather difficult, owing to the apparent catalytic effects of the walls. Thus, Allen (2) considers that methyl radicals and acetone can react at the wall to give methane and acetyl. The latter does not seem to dimerize on the wall, but only reacts with a methyl radical to form ethyl methyl ketone.

The higher hydrocarbons are considered to be formed by reactions such as the following:

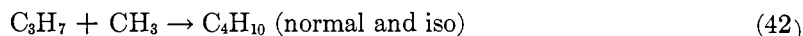

Since the acetone photolysis can become so complicated above 300°C., studies at these temperatures are probably of little help in determining the nature of the over-all scheme of decomposition.

Nothing has been said so far concerning the photolysis of acetone at wave lengths below 2000 Å. Manning (44) found that wave lengths of 1850–2000 Å. were effective in causing the decomposition of acetone. At acetone pressures around 90 mm. the products were found to be carbon monoxide, hydrogen, methane, ethylene, and ethane. The percentage of these products was found to vary considerably with time, probably owing to secondary reactions. The experiments of Manning were performed in reaction vessels containing fluorite windows which transmit light below 1850 Å. and, hence, were complicated by mercury resonance radiation (1849 Å.) effects. No mechanism for the decomposition was proposed by Manning, but some qualitative results may be stated: (1) the C—H bonds are broken to a considerable extent, hydrogen forming about 63 per cent of the products for complete decomposition of acetone at pressures of about 0.025 mm.; (2) small amounts of carbon dioxide are formed at low pressures; (3) either the methyl radicals, if formed, react mainly to give methane, or if ethane or ethylene is formed, these products react further and polymerize; (4) at higher pressures (90 mm.), secondary reactions such as $\text{H}_2 + \text{C}_2\text{H}_4 \rightarrow \text{C}_2\text{H}_6$ occur.

Howe and Noyes (37) studied the photolysis of acetone at about 1900 Å., using a quartz cell to remove light of wave length much below this value. The effect of mercury resonance radiation was also determined. At low pressures (2–8 mm. of acetone) carbon monoxide was found to constitute 50 per cent (within experimental error) of the reaction products. In agreement with Norrish, Crone, and Saltmarsh (53), Howe and Noyes (37) found the determination of ethane quite difficult, owing to solution in undecomposed acetone. Hence, the latter authors have based the quantum yield of acetone decomposed upon the quantum yield of carbon monoxide formed according to the over-all reaction:



At pressures of about 2 mm. the quantum yield was found to be about 0.6, decreasing slightly with pressure. An extrapolation to zero pressure would not necessarily appear to indicate an over-all quantum yield of unity. Hence, if the primary process is

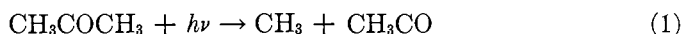

the recombination reaction



would appear to be important.

As mentioned previously, the extent of the reaction



is about 50 per cent at 1900 Å. which, if the primary process 1 had an efficiency of about unity, would explain the value of $\Phi_{\text{CO}} = 0.5$ obtained by Howe and Noyes at about 50 mm. acetone pressure. At this pressure reactions 1, 8, and 5 appear sufficient to explain the data for the photolysis of acetone with light of about 1900 Å. The presence or absence of biacetyl was not proved, since the absence of fluorescence may not indicate the absence of biacetyl at 1900 Å. and since only Φ_{CO} was determined, except in a few runs. Assuming no complicating factors, reactions 8 and 5 seem to be equally probably at 50 mm. pressure, since no biacetyl was found. At lower pressures, the reactions



or

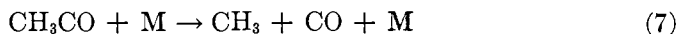

or

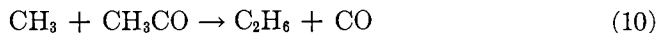

as well as



or



appear to enter into the scheme.

The addition of foreign gases (table 17) has the predicted effect of increasing the over-all yield for acetone decomposition. Specifically, reaction 6 or 7 becomes more important and 8 less important.

The presence of mercury effects an increase in the over-all quantum yield, probably owing to the formation of substances such as HgCH_3 by deactivation of the mercury (see table 18).

From the effect of added gases on the over-all quantum yield of acetone decomposed, it would appear that if the efficiency of the primary process (reaction 1) is not unity at 1900 Å., it is certainly very close to it.

A. Summary of reactions

I. Free-radical reactions



Necessary to explain biacetyl formation.



Necessary in the Spence and Wild mechanism but unnecessary in the free-radical mechanism.

TABLE 17
Effect of added gases on quantum yield of acetone decomposition
(Howe and Noyes (37))

ACETONE PRESSURE	FOREIGN GAS PRESSURE	QUANTUM YIELD	QUANTUM YIELD WITHOUT ADDED GAS	ADDED GAS
<i>mm.</i>	<i>mm.</i>			
1.82	9.8	0.81	0.61	CO ₂
1.81	9.8	0.85	0.61	
1.72	18.4	0.88	0.62	
2.12	2.23	0.69	0.61	N ₂
2.12	3.78	0.81	0.61	
2.34	7.38	0.74	0.61	C ₂ H ₆
2.32	7.13	0.75	0.61	
2.30	12.30	0.80	0.61	

TABLE 18
Effect of Hg(6¹P₁) on quantum yield for acetone decomposition
(Howe and Noyes (37))

ACETONE PRESSURE	APPARENT QUANTUM YIELD	CALCULATED QUANTUM YIELD IN ABSENCE OF Hg RESONANCE RADIATION	REMARKS
<i>mm.</i>			
1.51	0.73	0.62	Resonance radiation present
0.115	0.72	0.65	Trap in CO ₂ -CHCl ₃
0.124	0.88	0.65	
0.134	0.81	0.65	
20.4	0.53		Resonance radiation present
20.4	0.53		Resonance radiation removed
9.9	0.55	0.55	Resonance radiation present



No data to support this as being of more than minor importance.



Equivalent to reaction 1 followed by reaction 5.



The use of this following reaction 1 makes it possible to use

one primary process instead of the two of reaction 1 plus reaction 4. Here CH_3CO is considered to dissociate spontaneously.

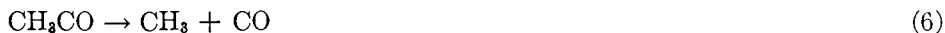

The lack of pressure dependence of the thermal reaction above 50–100 mm. allows for the use of a unimolecular reaction.



Below 25 mm. pressure, the thermal decomposition of CH_3CO is pressure dependent.



The three equations represent the reaction involved in the thermal decomposition of CH_3CO .



The low quantum yield of acetone decomposed after a primary decomposition process of nearly unit efficiency requires the reformation of acetone from its decomposition products.

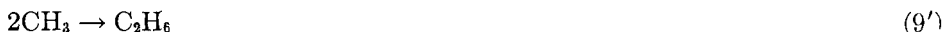

The formation of ethane has been found to be bimolecular at high pressures. Where specified, this equation represents the formation of ethane without consideration of the mode of formation (homogeneous or heterogeneous).



Necessary to explain the increase of $\Phi_{\text{C}_2\text{H}_6}$ with decreasing pressure at low pressures.



Arguments for and against this reaction.



The formation of $(\text{CH}_3\text{CO})_2$ has been found to occur in a manner similar to the homogeneous formation of ethane (reaction 9') at high pressures.



Necessary to explain the increase of $\Phi_{(\text{CH}_3\text{CO})_2}$ with decreasing pressure at low pressures.



With the exponent $y = 0.25$ the data of Spence and Wild agree with this equation. More thorough considerations might show this reaction to occur simultaneously with reaction 11' at high pressures.



This reaction has been shown not to occur.



Formation of large amounts of methane in the photolysis of acetone in the presence of hydrogen makes this reaction necessary.



One of the few ways in which methane can be formed from methyl radicals in the presence of acetone.



Following reaction 22, the presence of these two radicals indicates ethyl methyl ketone a logical product, although it has not been detected analytically owing to experimental difficulties.



This reaction is probably unimportant except at temperatures above 400°C.

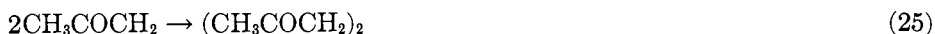

Logical following reaction 22, but biacetyl has not been detected, owing to experimental difficulties.



This reaction is probably quite unimportant, since the acetyl radical is quite unstable above 125°C., a temperature at which acetyl is not formed in large quantities except at high acetone pressures.



Probably important in the photolysis of ethyl methyl ketone, but unimportant in the photolysis of acetone, the concentration of ethyl methyl ketone being very low in this case except for large percentages of decomposition.

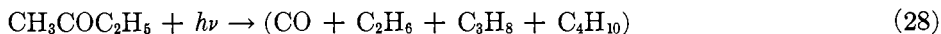

The ethyl methyl ketone photolysis is unimportant in the acetone photolysis except when large percentages of acetone are decomposed at elevated temperatures.

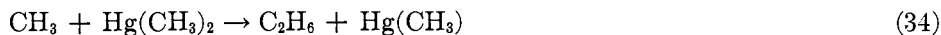
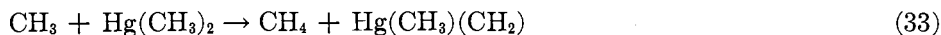
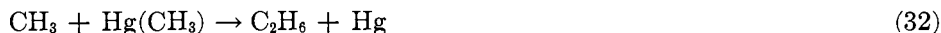

Reactions 29-34 can occur when acetone is photolyzed in the presence of mercury and dimethylmercury.



The polymerization of olefins is induced by the photolysis of acetone.

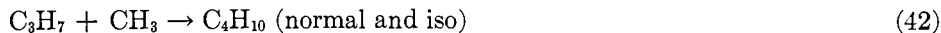

Reactions 39-42 are used to explain the high-temperature products of the photolysis of acetone.

II. Additional reactions of the Spence and Wild mechanism for the "banded" region near 3100 Å.

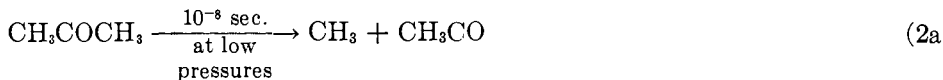

At low pressure the Spence and Wild mechanism predicts mainly radical formation.



At higher pressures, a second excited state is formed, this being used to explain the fluorescence of acetone and, with reactions 14, 15, and 16, to explain the decrease of $\text{C}_2\text{H}_6/\text{CO}$ as the cell size decreases.

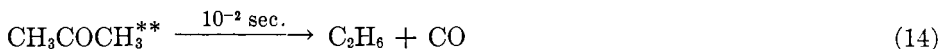

The time factor was determined partly from the data on the

decrease of C_2H_6/CO with cell size and from fluorescence data of biacetyl. A moderate and high pressure reaction.

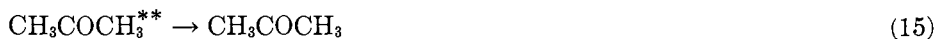

Deactivation by fluorescence or collision.



Since wall effects are quite small at 100 mm. pressure, this reaction should not be very important in this pressure range.

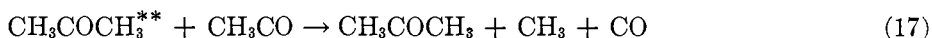

This reaction is used to explain the decrease in C_2H_6/CO with increasing intensity at high intensities and at moderate to high pressures of acetone (≥ 100 mm.)

III. ETHYL METHYL KETONE

The photolysis of the simple aliphatic ketones other than acetone has not been investigated to any great extent. Ethyl methyl ketone offers very interesting possibilities with regard to elucidating the mechanism of the photodecomposition of those ketones which undergo the Norrish Type I decomposition, namely

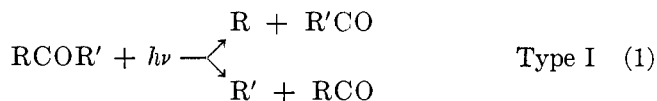

Acetone, of course, appears to decompose to a large extent, if not wholly, according to this Type I mechanism. If acetone decomposes to ethane and carbon monoxide without the intermediate formation of radicals, by analogy we would expect ethyl methyl ketone to do the same, at least after the absorption of light near 3100 Å. Since the absorption spectrum of ethyl methyl ketone shows no structure around 3100 Å. (22), it might not be proper to compare the results of the photolysis of acetone and ethyl methyl ketone in this wave-length region. Such a comparison would probably be proper if indisputable evidence is obtained that the photolysis of acetone in the "banded" region follows the same mechanism as it does in the continuous region from about 2200 Å. to 3050 Å.

Pearson (60) and Glazebrook and Pearson (27) have demonstrated by use of the Paneth mirror technique that radicals are produced in the photolysis of ethyl methyl ketone. This is to be expected, since this ketone does not differ markedly from acetone. The presence of the free radicals in the photolysis of ethyl methyl ketone thus indicates that at least part of the decomposition takes place according to reaction I, which we may write as

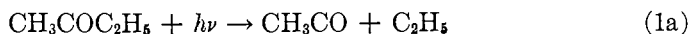

and



Norrish and Appleyard (52) analyzed the products of the photolysis of this ketone and found that of the hydrocarbons formed ethane, propane, and butane were present in about equal amounts, these forming 70–80 per cent of the hydrocarbon products (table 19). These authors also found 20–25 per cent of the hydrocarbons formed to be ethylene. The conditions of these studies were the use of ethyl methyl ketone vapor, above the boiling liquid, photolyzed with the full intensity of a mercury arc. Thus, the temperature of the vapor was about 80°C., at which temperature the acetyl radical is fairly stable and the propionyl radical, as will be discussed later, is quite unstable, and readily dissociates to CO and C₂H₅. Equal quantities of ethane, propane, and butane would require,

TABLE 19
Photolysis of ethyl methyl ketone
Composition of products in per cent
(Norrish and Appleyard (52))

EXPT.	CO	CH ₄	C ₂ H ₄	C ₂ H ₆	C ₃ H ₈	C ₄ H ₁₀	CO ₂
1	45.5	5.4	9.05	13.2	27		0
2	50.0	3.05	12.3	9.8	11.6	12.5	0.55
3	51.0	4.3	4.9	39.8			

TABLE 20
The photolysis of CH₃COC₂H₅ in the presence of iodine at 70°C.
Mercury arc
Gorin (30))

PRESSURE OF CH ₃ COC ₂ H ₅	WAVE LENGTH	PRESSURE OF I ₂	RI	CO	C ₂ H ₄
mm.	Å.	mm.	moles × 10 ⁶	moles × 10 ⁶	moles × 10 ⁶
65	3130	4	22.2	1.05	0.82
70	3130	2	21.2	0.89	0.74
67	Unfiltered	4	17.2	1.24	1.12
72	Unfiltered	2	17.6	1.33	1.24

from the work of Norrish and Appleyard, that 70–80 per cent of the decomposition proceed according to reactions 1a and 1b with no process of the type CH₃COC₂H₅ → C₃H₈ + CO allowable. The ethylene probably is explained by a disproportionation reaction between two ethyl radicals, possibly on the walls of the reaction cell.

As mentioned by Steacie (77), the inefficiency of the simple bulb-to-bulb distillations used by Norrish and Appleyard probably explains the 1:1:1 ratio of the three hydrocarbons obtained rather than 1.00:1.74:0.83 for C₂H₆:C₃H₈:C₄H₁₀ as calculated by Moore and Taylor (48) from statistical considerations, for equal concentrations of the methyl and ethyl radicals.

Gorin (30) has studied the photolysis of ethyl methyl ketone in the presence of iodine and arrived at essentially the same conclusions as did Norrish and Appleyard (table 20).

Since the amount of carbon monoxide formed in the presence of iodine is quite small compared to the amounts of RI, the main course of the photolysis of ethyl methyl ketone must be reactions 1a and 1b. Gorin indicates that some of the decomposition may proceed according to the one-step mechanism

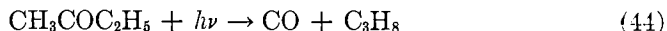

this occurring to the extent of 6.5 per cent in the unfiltered arc and 3.5 per cent at 3130 Å., both figures for 70°C.

Gorin's studies of ethyl methyl ketone were not nearly as complete as his studies on acetone. Further, since he did not separate the alkyl or acyl iodides, this work should not be considered as giving the complete mechanism of the ethyl methyl ketone photolysis (table 21).

Moore and Taylor (48) have studied the proportions of the three hydrocarbons, ethane, propane, and butane, and have also compared the ratios of these with the

TABLE 21

Comparison of the rates of photolysis of CH_3COCH_3 and $\text{CH}_3\text{COC}_2\text{H}_5$ in the presence of iodine and unfiltered light

(Gorin (30))

PRESSURE	KETONE	TIME	RI
<i>mm.</i>		<i>min.</i>	<i>moles $\times 10^8$</i>
90	$\text{CH}_3\text{COC}_2\text{H}_5$	40	24.6
90	CH_3COCH_3	40	21.7
90	$\text{CH}_3\text{COC}_2\text{H}_5$	40	22.1
90	CH_3COCH_3	40	20.6

ratios expected according to calculations on the number of collisions of the two radicals methyl and ethyl. Thus, if



the ratio of the number of collisions is

$$a:b:c = 1.00:1.74:0.83$$

The experimental values obtained were

$$\text{C}_2\text{H}_6:\text{C}_3\text{H}_8:\text{C}_4\text{H}_{10} = 1.00:1.54:1.00$$

As in the case of the high-temperature photolysis of acetone, the rate of formation of methane from ethyl methyl ketone increases markedly with temperature (table 22).

As can be seen from table 22, the amounts of propane and butane formed decrease with temperature, while ethane formation remains essentially constant. This and the methane formation are probably explained by reactions 27 and 46.

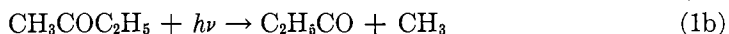
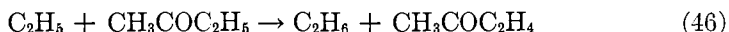
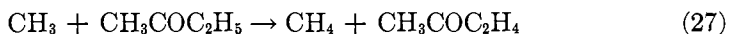

The relative importance of reactions 1a and 1b at room temperature for absorption of light near 3000 Å. has been determined by Ells and Noyes (23) after comparing the quantum yields of carbon monoxide formation from acetone, ethyl methyl ketone, and diethyl ketone. From diethyl ketone only the propionyl radical can be formed. The high value of Φ_{CO} from diethyl ketone, approximately unity at 36 mm. pressure, indicates that the propionyl radical is very unstable and probably dissociates to a very large extent even after absorption of light of about 3000 Å. Thus, if reaction 1b proceeded to a very large extent at room temperature the quantum yield of carbon monoxide formation would be expected to be appreciably higher for ethyl methyl ketone than for acetone. Actually, Ells and Noyes (23) found Φ_{CO} for ethyl methyl ketone to be very nearly the same as for acetone. This would indicate that reaction 1a is much more important at room temperature than is reaction 1b at the relatively

TABLE 22
Percentage composition of the photolysis products of $\text{CH}_3\text{COC}_2\text{H}_5$
(Moore and Taylor (48))

TEMPERATURE, °C.....	90	110	155	200
H_2	0.4	0.1	0.3	0.0
CO	47.5	49.0	47.0	48.5
CH_4	3.4	4.4	9.0	18.0
C_2H_4	2.2	0.5	1.7	3.0
C_2H_6	11.5	13.0	14.5	12.5
C_3H_8	19.1	20.0	18.6	11.0
C_4H_{10}	13.2	13.0	9.0	7.0
C_4H_8	1.5		0.0	

long wave length of 3000 Å. At lower wave lengths or at higher temperatures, reaction 1b may become as important as 1a.

Ells and Noyes (22) have also suggested that symmetrical ketones are formed when ethyl methyl ketone is photolyzed at about 3000 Å. This would be expected on the basis of reactions 1a, 1b and reactions such as 8 and 47:



Reaction 47 is probably unimportant in view of the instability of the propionyl radical, but reaction 8 is quite important, as also shown in the case of the acetone photolysis.

The effect of elevated temperature on the quantum yields of carbon monoxide and methane has been studied by Ells and Noyes (22) and found not to have chain character (table 23).

At 1850–2000 Å. Ells and Noyes (22) found Φ_{CO} to approach unity, as might be expected. Thus, Φ_{CO} from acetone at these wave lengths is about 0.7. With the formation of the more unstable propionyl radical, Φ_{CO} would be expected to be greater than 0.7 on the basis of the free-radical theory (see table 24).

In general, the photolysis of ethyl methyl ketone appears to follow a completely free-radical mechanism, the formation of ethylene possibly being explained by

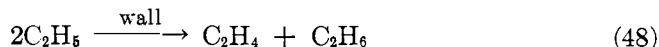

and at higher temperatures by reaction 27 or 46, followed by



At room temperature and low pressures biacetyl is probably formed according to the reaction:

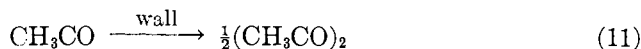

The presence of biacetyl in the photolysis of ethyl methyl ketone has been demonstrated by Matheson and Zabor (46), who found the green fluorescence characteristic of biacetyl when this ketone is irradiated with light from a mercury arc.

TABLE 23
Quantum yields of carbon monoxide and methane at elevated temperature
(Ells and Noyes (22))

KETONE PRESSURE	TEMPERATURE	ϕ_{CO}	$\frac{\text{CO}}{\text{CH}_4}$	ϕ_{CH_4}
<i>mm.</i>	$^{\circ}\text{C.}$			
43	105-110	0.79	4.2	0.19
4.75	160-165	0.79	4.0	0.20
45	160-165	0.85	2.2	0.38
43	195-200	0.71	1.5	0.47

IV. DIETHYL KETONE

Diethyl ketone has not been studied very extensively, but the work that has been reported indicates that the photolysis of this ketone yields products that would be predicted on the basis of the free-radical theory.

Pearson and Purcell (60) have demonstrated the formation of ethyl radicals during the photolysis of diethyl ketone by use of the Paneth mirror technique. The authors isolated and identified triethylarsine dimercurichloride. Danby and Hinshelwood (17) also were able to show the presence of radicals when diethyl ketone is photolyzed by studies on the free-radical-induced polymerization of olefins (table 14 and figure 10).

Matheson and Zabor (45) have shown that the fluorescence observed when diethyl ketone is irradiated with ultraviolet light is nearly identical with that observed when propionaldehyde is irradiated. By analogy with acetone, ethyl methyl ketone, and acetaldehyde, which give similar fluorescence spectra, it seems likely that the fluorescence from diethyl ketone and propionaldehyde arises from bipropionyl, formed from the combination of two propionyl radicals.

Ells and Noyes (22) studied the photodecomposition of diethyl ketone in the regions 1850-2000 Å. and near 3000 Å. at 25°C. At the lower wave-length region

the quantum yield of carbon monoxide formation was found to rise from 0.82 at 38 mm. ketone pressure to 0.95 at 4 mm. pressure. In view of the work of Matheson and Zabor a probable primary step in the photolysis of this ketone is:



At about 3000 Å. the quantum yield of carbon monoxide formation was found by Ells and Noyes to rise from 0.67 at 10 mm. pressure to 1.04 at 36 mm. pressure. Thus, in both wave-length regions, 1850–2000 Å. and 3000 Å., Φ_{CO} tends toward unity. In view of this, the propionyl radical is apparently very unstable, unless it enters into some very efficient carbon monoxide-producing reaction, and reaction 51 would appear to proceed to a large extent at all wave lengths.



The method of formation of bipropionyl has not been studied because of lack of methods for detecting very small amounts of this substance. However, at low pressures it might be expected to be formed heterogeneously at moderate intensities, as is biacetyl.

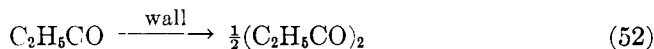

The recombination of propionyl and ethyl radicals *possibly* accounts for Φ_{CO} being less than unity at higher pressures (38 mm.)



At 1850–2000 Å. Ells and Noyes (22) found that 77–88 per cent of the ethyl radicals formed combined to form butane, the remainder apparently disproportionating to give ethane and ethylene, these being found in equal amounts.

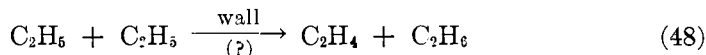

These equations explain very satisfactorily the observed products. An alternative reaction that might be postulated to explain the high value of Φ_{CO} is reaction 54, if this has a very low energy of activation.



There is no advantage in the use of this equation, since if it proceeded to a large extent, ethane and ethylene would have a very small probability of formation, contrary to experiment.

A comparison of the quantum yields of carbon monoxide formation from acetone, ethyl methyl ketone, and diethyl ketone is given in table 24.

V. *n*-BUTYL METHYL KETONE

The photolysis of *n*-butyl methyl ketone was first studied by Norrish and Appleyard (52). Acetone and propylene were found to be the major products,

these in approximately equivalent amounts, when the vapor over the boiling ketone (b.p. 127°C.) was irradiated with a hot mercury arc. The percentage composition of the gaseous products is given in table 25.

Experiment 3 was performed in the presence of the acetone from experiment 2, and the increase in carbon monoxide and ethane in the former is probably due to decomposition of acetone. Thus, under the conditions of the experiments made by Norrish and Appleyard, at least part of the carbon monoxide did not arise from an immediate consequence of the *n*-butyl methyl ketone.

TABLE 24

Comparison of the quantum yields of carbon monoxide formation from acetone, ethyl methyl ketone, and diethyl ketone

(Ells and Noyes (23))

WAVE-LENGTH REGION	PRESSURE	(CH ₃) ₂ CO	CH ₃ COC ₂ H ₅	(C ₂ H ₅) ₂ CO
A.	mm.			
1850-2000	20	0.52	0.76	0.88
1850-2000	8	0.56	0.78	0.90
1850-2000	4	0.59	0.78	0.95
1850-2000	1	0.62	0.82	0.98*
1850-2000	0.3	0.64	0.86	0.99*
3000	10	0.095†	0.082	0.67
3000	10	0.095†	0.11	0.98
3000	21	0.095†	0.12	0.97
3000	36	0.095†	0.12	1.04

* Obtained by rough graphical extrapolation.

† This was taken as a standard after many determinations.

TABLE 25

Composition of gaseous products in per cent

(Norrish and Appleyard (52))

EXPT.	CO	H ₂	CH ₄	C ₂ H ₆	C ₂ H ₄
1	11.4	2.0	0.95	80.6	5.1
2	15.0	1.6	1.05	73.7	10.3
3	19.2	1.6	1.7	63.5	14.1

From these data Norrish and Appleyard proposed the Type II method of decomposition of this ketone



Bamford and Norrish (7) found essentially the same results when *n*-butyl methyl ketone is photolyzed in paraffin solution.

Davis and Noyes (18) photolyzed *n*-butyl methyl ketone vapor at about 25°C. and 12 mm. pressure with the full mercury arc and also using approximately monochromatic 3130 Å. radiation. Propylene was found to be a major product, being formed to an extent of about ten times the carbon monoxide rate

of formation. Traces of ethane were found, but the methods of analysis were not accurate enough to give exact data on this compound. Although a product was found that analyzed as acetone, this substance was not found to be equivalent to propylene; rather, equal only to about 75 per cent of the latter. In view of the solubility of acetone in *n*-butyl methyl ketone it is impossible to say from this work whether acetone and propylene are really equivalent. However, since only about 1 per cent of the hexanone was decomposed, the carbon monoxide formed probably did not result from the secondary photolysis of acetone.

Wilson and Noyes (75) studied the photolysis of *n*-butyl methyl ketone at about 3130 and 2537 Å. Some of their results may be summarized as follows: (1) at 27°C. the quantum yield of C₃-hydrocarbons (propylene plus propane) is about 0.34, independent of intensity and pressure; (2) the quantum yield of C₃-hydrocarbons is independent of temperature from 25–115°C. within experimental error and equal to 0.39 ± 0.02 ; (3) Φ_{C_3} is approximately the same for 3130 and 2537 Å.; (4) the quantum yield of acetone plus other products after the removal of C₃-hydrocarbons is about 0.26 at 3130 Å. and 27°C., increasing slightly with decreasing wave length; (5) the carbon monoxide yield is small but increases with temperature.

Wilson and Noyes also reported $\Phi_{C_2H_6}$ about 0.1, this being independent of intensity and wave length, but increasing slightly with temperature. Whether this substance, reported as ethane, is really ethane, seems quite doubtful. Norrish and Appleyard (52) and Davis and Noyes (18) found carbon monoxide in appreciable quantities, the latter using the same apparatus as employed by Wilson and Noyes. It seems probable that the -195°C. fraction obtained by Wilson and Noyes was carbon monoxide with traces of methane and ethane rather than nearly pure ethane.

Wilson and Noyes detected biacetyl in the photolysis of *n*-butyl methyl ketone. This may have resulted from the secondary decomposition of acetone, since a long run, using an unfiltered mercury arc, was made in order to obtain a measurable quantity of biacetyl. However, in view of the small amount obtained, it is also possible that the acetyl radical is formed in one of several possible minor primary processes.

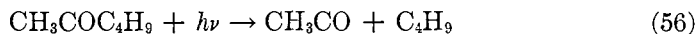

If such a process made a small contribution to the primary step, at the low pressures of ketone used by Wilson and Noyes (12 mm.), most of the acetyl radicals would be expected to form biacetyl heterogeneously according to equation 11:

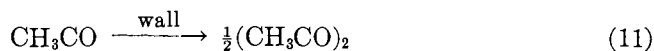

At higher temperatures, where the acetyl radical is quite unstable, we would expect



or

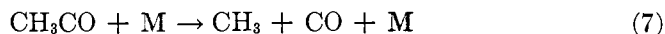

followed by



and



Whether ethane is formed in more than negligible amounts has still to be proved; hence the value of reaction 56 in explaining the formation of biacetyl or other products is to be questioned. Wilson and Noyes have used reaction 56 to explain the products of the photolysis of butyl methyl ketone, especially the inequality of propylene and acetone. These authors proposed that equation 56 also be followed by



to explain the formation of propylene. Further, these authors suggested

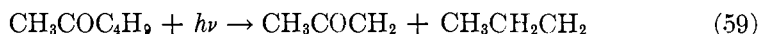

followed by



However, Moore and Taylor (48), studying the mercury-photosensitized hydrogenation of propylene, found reaction 61 to go to an extent of only about 26 per cent compared with 64 per cent of reaction 62:



Moore and Taylor (48), studying the mercury-photosensitized hydrogenation of butene, found only 1 per cent propane, 29 per cent butane, and 66 per cent octane, indicating that the extent of reaction 58 is small, at least at low temperatures, compared with reactions 63 and 64.

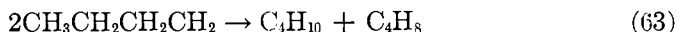

Recent work by Davis and Noyes (19) indicates that at low temperatures the main reaction must be that given by reaction 55; i.e., a direct split into the final products. Up to 100°C. acetone and propylene were found to be formed in equal amounts. From this work $\Phi_{\text{C}_3\text{H}_6} = 0.45 \pm 0.05$ at 100°C., as compared with a value of 0.39 ± 0.02 found by Wilson and Noyes (75). Studies on the effect of temperature (19) showed that acetone was formed up to 300°C. and therefore could not be formed by the reaction 8, owing to the great instability of the acetyl radical.



At higher temperatures, above 100°C., the radical forming primary process 56 appears to become increasingly important, the yields of carbon monoxide,

methane, ethane, propylene, and C₄-hydrocarbons increasing considerably. At these higher temperatures reaction 58 becomes quite important.

VI. REFERENCES

- (1) AKEROYD, E. I., AND NORRISH, R. G. W.: *J. Chem. Soc.* **1936**, 890.
- (2) ALLEN, A. O.: *J. Am. Chem. Soc.* **63**, 708 (1941).
- (3) ALMY, G. M., AND ANDERSON, S.: *J. Chem. Phys.* **8**, 805 (1940).
- (4) ALMY, G. M., FULLER, H. Q., AND KINZER, G. D.: *Phys. Rev.* **55**, 238 (1939).
- (5) ALMY, G. M., FULLER, H. Q., AND KINZER, G. D.: *J. Chem. Phys.* **8**, 37 (1940).
- (6) ANDERSON, H. W., AND ROLLEFSON, G. K.: *J. Am. Chem. Soc.* **63**, 816 (1941).
- (7) BAMFORD, C. H., AND NORRISH, R. G. W.: *J. Chem. Soc.* **1938**, 1531.
- (8) BARAK, M., AND STYLE, D. W. G.: *Nature* **135**, 307 (1935).
- (9) BAWN, C. E. H.: *Trans. Faraday Soc.* **34**, 598 (1938).
- (10) BENSON, S. W., AND FORBES, G. S.: *J. Am. Chem. Soc.* **65**, 1399 (1943).
- (11) BERTHELOT, D., AND GAUDECHON, H.: *Compt. rend.* **155**, 207 (1912).
- (12) BOWEN, E. J., AND THOMPSON, H. W.: *Nature* **133**, 571 (1934).
- (13) BOWEN, E. J., AND WATTS, H. G.: *J. Chem. Soc.* **1926**, 1607.
- (14) BURTON, M., TAYLOR, H. A., AND DAVIS, T. W.: *J. Chem. Phys.* **7**, 1080 (1939).
- (15) CRONE, H. G., AND NORRISH, R. G. W.: *Nature* **132**, 241 (1933).
- (16) DAMON, G. H., AND DANIELS, F.: *J. Am. Chem. Soc.* **55**, 2363 (1933).
- (17) DANBY, C. J., AND HINSHELWOOD, C. N.: *Proc. Roy. Soc. (London)* **A179**, 169 (1941).
- (18) DAVIS, W., JR., AND NOYES, W. A., JR.: *J. Am. Chem. Soc.* **64**, 2676 (1942).
- (19) DAVIS, W., JR., AND NOYES, W. A., JR.: *J. Am. Chem. Soc.*, to be published.
- (20) DUNCAN, A. B. F.: *J. Chem. Phys.* **3**, 131 (1935).
- (21) DUNCAN, A. B. F., ELLS, V. R., AND NOYES, W. A., JR.: *J. Am. Chem. Soc.* **58**, 1454 (1936).
- (22) ELLS, V. R., AND NOYES, W. A., JR.: *J. Am. Chem. Soc.* **60**, 2031 (1938).
- (23) ELLS, V. R., AND NOYES, W. A., JR.: *J. Am. Chem. Soc.* **61**, 2492 (1939).
- (24) FELDMAN, M. H., BURTON, M., RICCI, J. E., AND DAVIS, T. W.: *J. Chem. Phys.* **13**, 440 (1945).
- (25) FELDMAN, M. H., RICCI, J. E., AND BURTON, M.: *J. Chem. Phys.* **10**, 618 (1942).
- (26) FISK, C. F., AND NOYES, W. A., JR.: *J. Chem. Phys.* **2**, 654 (1934).
- (27) GLAZEBROOK, H. H., AND PEARSON, T. G.: *J. Chem. Soc.* **1937**, 567.
- (28) GORIN, E.: *Acta Physicochim. U.R.S.S.* **8**, 513 (1938).
- (29) GORIN, E.: *Acta Physicochim. U.R.S.S.* **9**, 681 (1938).
- (30) GORIN, E.: *J. Chem. Phys.* **7**, 256 (1939).
- (31) GORIN, E., KAUZMANN, W., WALTER, J., AND EYRING, H.: *J. Chem. Phys.* **7**, 633 (1939).
- (32) GRAHAME, D. C., AND ROLLEFSON, G. K.: *J. Chem. Phys.* **8**, 98 (1940).
- (33) HADEN, W. L., JR., MEIBOHM, E. P. H., AND RICE, O. K.: *J. Chem. Phys.* **8**, 998 (1940).
- (34) HENRIQUES, F. C., JR., AND NOYES, W. A., JR.: *J. Am. Chem. Soc.* **62**, 1038 (1940).
- (35) HERR, D. S., MATHESON, M. S., AND WALTERS, W. D.: *J. Am. Chem. Soc.* **63**, 1464 (1941).
- (36) HERR, D. S., AND NOYES, W. A., JR.: *J. Am. Chem. Soc.* **62**, 2052 (1940).
- (37) HOWE, J. P., AND NOYES, W. A., JR.: *J. Am. Chem. Soc.* **58**, 1404 (1936).
- (38) HOWLAND, J. J., JR., AND NOYES, W. A., JR.: *J. Am. Chem. Soc.* **63**, 3404 (1941).
- (39) HOWLAND, J. J., JR., AND NOYES, W. A., JR.: *J. Am. Chem. Soc.* **66**, 974 (1944).
- (40) IREDALE, T., AND LYONS, L. E.: *J. Chem. Soc.* **1944**, 588.
- (41) KIRKBRIDE, F. W., AND NORRISH, R. G. W.: *Trans. Faraday Soc.* **27**, 404 (1931).
- (42) LEERMAKERS, J. A.: *J. Am. Chem. Soc.* **56**, 1899 (1934).
- (43) LEIGHTON, P. A.: *J. Phys. Chem.* **42**, 749 (1938).
- (44) MANNING, W. M.: *J. Am. Chem. Soc.* **56**, 2589 (1934).
- (45) MATHESON, M. S., AND NOYES, W. A., JR.: *J. Am. Chem. Soc.* **60**, 1857 (1938).
- (46) MATHESON, M. S., AND ZABOR, J. W.: *J. Chem. Phys.* **7**, 536 (1939).

- (47) MITCHELL, J. W., AND HINSHELWOOD, C. N.: Proc. Roy Soc. (London) **A157**, 32 (1937).
- (48) MOORE, W. J., JR., AND TAYLOR, H. S.: J. Chem. Phys. **8**, 466 (1940).
- (49) MOORE, W. J., JR., AND TAYLOR, H. S.: J. Chem. Phys. **8**, 504 (1940).
- (50) NORRISH, R. G. W.: Trans. Faraday Soc. **30**, 107 (1934).
- (51) NORRISH, R. G. W.: Nature **133**, 837 (1934).
- (52) NORRISH, R. G. W., AND APPLEBYARD, M. E. S.: J. Chem. Soc. **1934**, 874.
- (53) NORRISH, R. G. W., CRONE, H. G., AND SALTMARSH, O.: J. Chem. Soc. **1934**, 1456.
- (54) NOYES, W. A., JR.: Rev. Modern Phys. **5**, 280 (1933).
- (55) NOYES, W. A., JR., DUNCAN, A. B. F., AND MANNING, W. M.: J. Chem. Phys. **2**, 717 (1934).
- (56) NOYES, W. A., JR., AND HENRIQUES, F. C., JR.: J. Chem. Phys. **7**, 767 (1939).
- (57) PANETH, F., AND HOFEDITZ, W.: Ber. **62**, 1335 (1929).
- (58) PANETH, F. A., HOFEDITZ, W., AND WUNSCH, A.: J. Chem. Soc. **1935**, 372.
- (59) PANETH, F., AND LAUTSCH, W.: Ber. **64**, 2708 (1931).
- (60) PEARSON, T. G.: J. Chem. Soc. **1934**, 1718.
- (61) PEARSON, T. G., AND PURCELL, R. H.: J. Chem. Soc. **1935**, 1151.
- (62) PORTER, C. W., AND IDDINGS, C.: J. Am. Chem. Soc. **48**, 40 (1926).
- (63) PRILESHAJEVA, N., AND TEREININ, A.: Trans. Faraday Soc. **31**, 1483 (1935).
- (64) RICE, F. O.: J. Am. Chem. Soc. **56**, 488 (1934).
- (65) RICE, F. O., AND HERZFELD, K. F.: J. Am. Chem. Soc. **56**, 284 (1934).
- (66) RICE, F. O., JOHNSON, W. R., AND EVERING, B. L.: J. Am. Chem. Soc. **54**, 3529 (1932).
- (67) ROOF, J. G., AND BLACET, F. E.: J. Am. Chem. Soc. **63**, 1126 (1941).
- (68) ROSS, W. F., AND KISTIAKOWSKY, G. B.: J. Am. Chem. Soc. **56**, 1112 (1934).
- (69) SAUNDERS, K. W., AND TAYLOR, H. A.: J. Chem. Phys. **9**, 616 (1941).
- (70) SPENCE, R., AND WILD, W.: Nature **138**, 206 (1936).
- (71) SPENCE, R., AND WILD, W.: J. Chem. Soc. **1937**, 352.
- (72) SPENCE, R., AND WILD, W.: J. Chem. Soc. **1941**, 590.
- (73) TAYLOR, H. S., AND JUNGERS, J. C.: Trans. Faraday Soc. **33**, 1353 (1937).
- (74) TAYLOR, H. S., AND ROSENBLUM, C.: J. Chem. Phys. **6**, 119 (1938).
- (75) WILSON, J. E., AND NOYES, W. A., JR.: J. Am. Chem. Soc. **65**, 1547 (1943).
- (76) WINKLER, C. A.: Trans. Faraday Soc. **31**, 761 (1935).

Books

- (77) STEACIE, E. W. R.: *Atomic and Free Radical Reactions*. Reinhold Publishing Corporation, New York (1946).